

PicoVNA[®] 100 Series

6 GHz and 8.5 GHz vector network analyzers

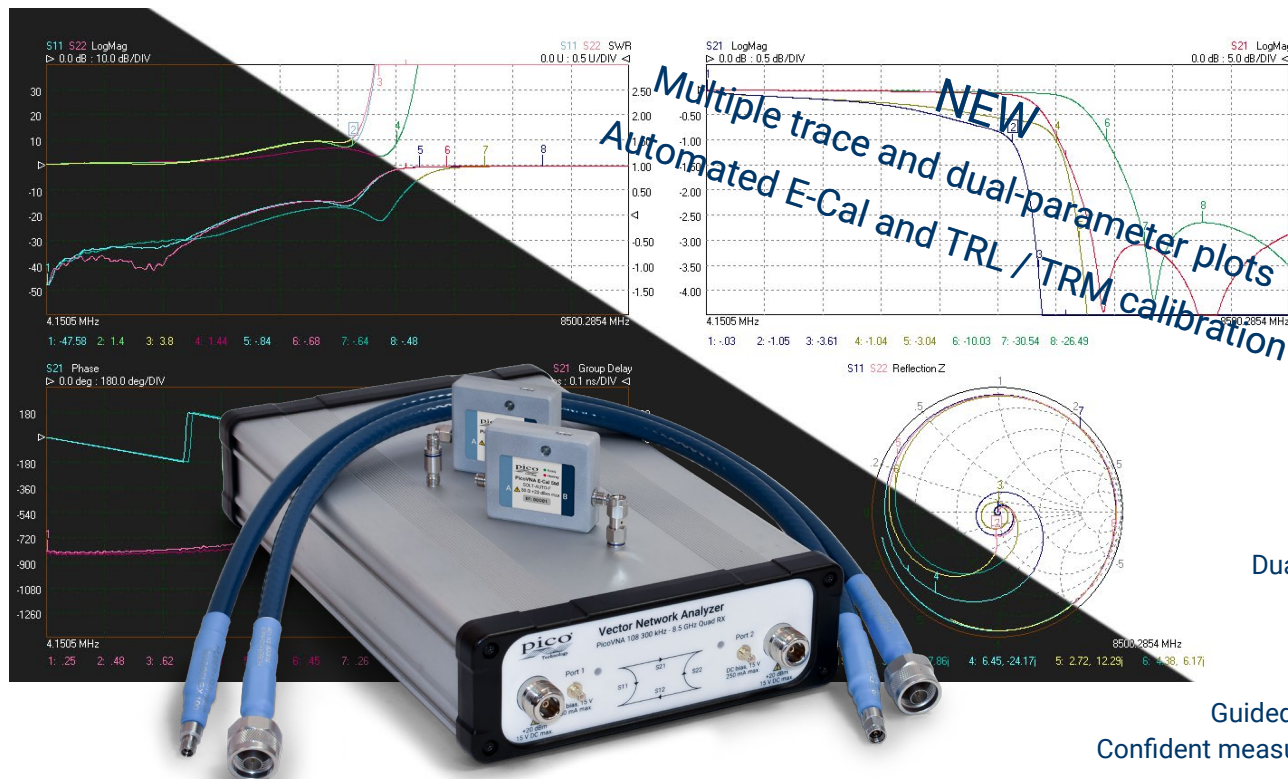

Professional and portable performance at low cost

- 300 kHz to 6 or 8.5 GHz operation
- High speed, up to 5500 dual-port S-parameters per second
- > 10 000 $S_{11} + S_{21}$ per second
- Quad RX four-receiver architecture for best accuracy
- Up to 124 dB dynamic range at 10 Hz bandwidth
- 0.005 dB RMS trace noise at maximum bandwidth of 140 kHz
- Half-rack, small-footprint, lightweight package

- Reference plane offsetting and de-embedding
- Time domain and port impedance transformations
- Up to 4 live + 4 memory traces on dual y-axis display channels
- Save on trigger for high-speed device profiling (PicoVNA 108)
- Dual-frequency mixer measurements with VSWR correction (PicoVNA 108)
- Phase meter, P1dB, AM to PM, and stand-alone signal generator utilities

- Male and female SOLT and automated E-Cal calibration standards
- Guided 8/12-term, SOLT, TRL and TRM calibrations including unknown-through
- Confident measurement based on traceable data for all calibration and check standards

Vector network analysis for the many

Once the domain of an elite few, microwave measurement has encroached into the lives of scientists, educators, surveyors, inspectors, engineers and technicians alike. Today's microwave measurements need to be straightforward, portable, accurate, cost-effective, easy to learn and as fast and automated as possible.

PicoVNAs are all-new, UK-designed, professional USB-controlled, laboratory grade vector network instruments of unprecedented performance, portability and value for money. Despite their simple outline, small footprint and low cost, the instruments boast a four-receiver architecture to minimize the uncorrectable errors, delays and unreliability of internal transfer switches.

The PicoVNA 108 delivers an exceptional dynamic range of 124 dB at 10 Hz (118 dB for the PicoVNA 106) and less than 0.006 dB RMS trace noise at its maximum operating bandwidth of 140 kHz. The instruments can also gather all four S-parameters at each frequency point in just 182 μ s (PicoVNA 106) or 189 μ s (PicoVNA 108), or $S_{11} + S_{21}$ in less than 100 μ s. In other words, a 201 point 2-port .s2p Touchstone file in less than 38 ms or up to two .s1p files in less than 20 ms. Their low price makes them cost-effective as deep dynamic range scalar network analyzers or single-port vector reflectometers as well as full-function dual-port, dual-path vector network analyzers. They are affordable in the classroom, in small businesses and even in amateur workshops, yet capable of meeting the needs of all users up to the laboratory or production test technician or the metrology expert.



Metrology and working standard accessories

6 GHz and 8.5 GHz models

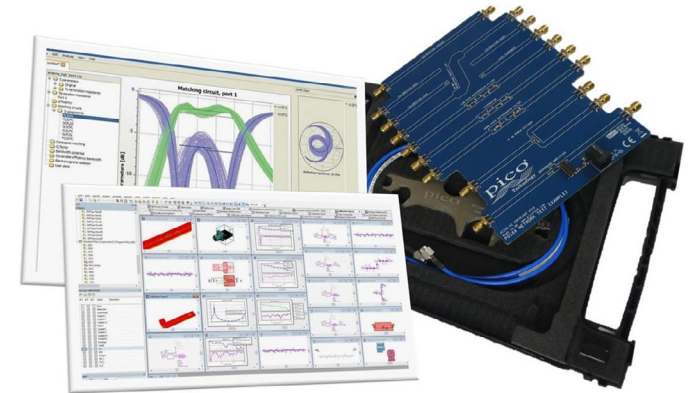

Teaching aids and CAD integrations

Vector Network Analysis in the field, the work place or as embedded function

The PicoVNAs' small size, light weight and low cost suit them to field service, installation test, embedded and classroom applications. With their remote automation capability, they are also attractive in applications such as:

- Test automation, including multiple VNA control and measurement
- Manufacturers needing to integrate a reflectometry or transmission measurement core
- Inspection, test, characterization and calibration in the manufacture, distribution and service center industries
 - Electronics component, assembly and systems, and interface/interconnect ATE (cable, PCB and wireless)
 - Material, geological, life science and food sciences; tissue imaging; penetrating scan and radar
- Broadband cable and harness test and matching at manufacture and installation, and fault-over-life monitoring
- Antenna matching and tuning

Software development kits, including code examples in MATLAB and MATLAB RF toolbox, LabVIEW, C, C# and Python, are all available for download from Pico Technology's GitHub pages. Examples include multiple instrument addressing and control.

Multiple-unit remote control

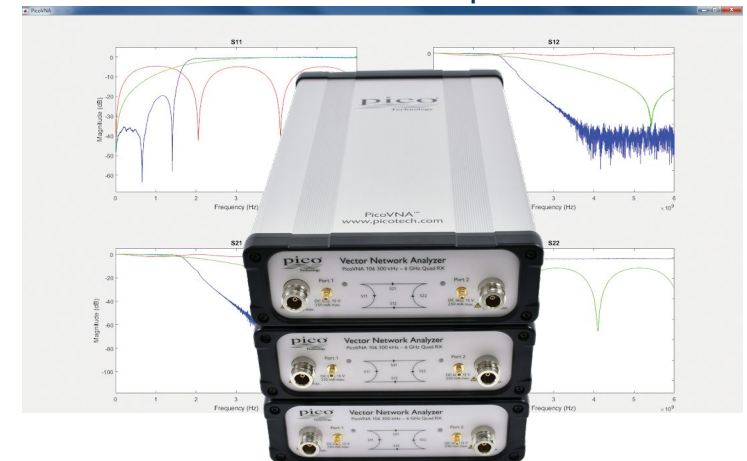

Quad RX four-receiver, single-sweep, architecture

The PicoVNAs integrate a fast-stepping sine-wave signal source with a very fast-settling port transfer switch. Faster than dual-sweep competitor VNAs, within a single frequency sweep, at each frequency point, the PicoVNAs stimulate both ports in turn and twice measure phase and amplitude of incident, reflected and transmitted waves at the four receivers. This could be achieved with a degree of accuracy with a single source, a transfer switch and two receivers; the latter inputs being switched through a further pair of transfer switches. Alternatively, three receivers can be used with an additional input transfer switch. The PicoVNA, however, uses four receivers. This eliminates the receiver input transfer switch errors (chiefly leakage and crosstalk) that cannot otherwise be corrected. These residual errors are always present in two- and three-receiver architectures and lead to lower accuracy than that of the *Quad RX* design.

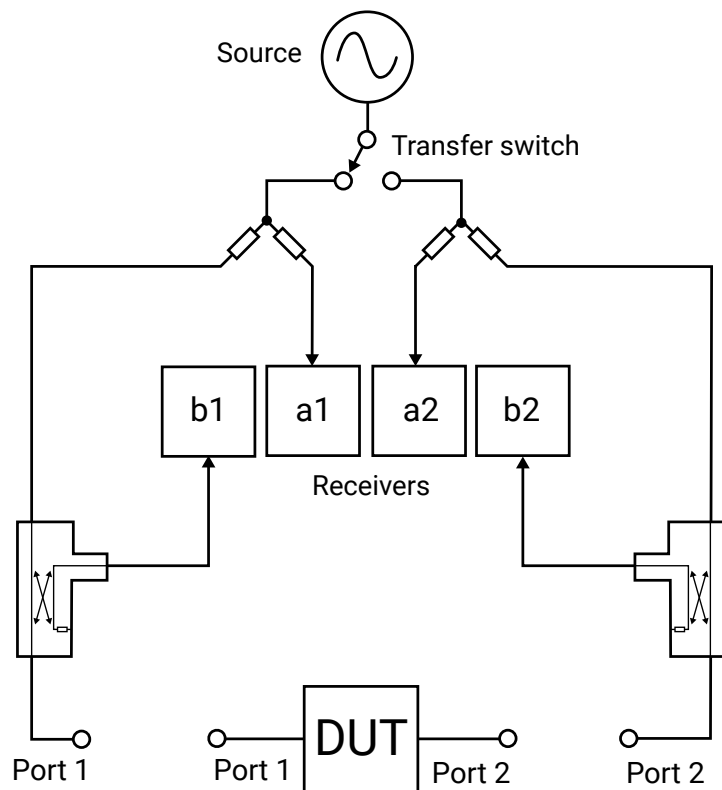

Support for 8 and 12-term calibration and the *unknown through*

Almost all vector network analyzers are calibrated for twelve error sources (six for each signal direction). This is the so-called *12-term calibration*, which experienced VNA users are used to performing fairly regularly. In a four-receiver design some error sources are so reduced that *8-term calibration* becomes possible, along with an important and efficient calibration technique known as the *unknown through*. This gives the ability to use any *through* interconnect (including the DUT) during the calibration process, vastly simplifying the procedure and reducing the number of calibration standards that need to be maintained. Advanced vector network analyzer users will be pleased to know that internal a-wave and b-wave data can be exported for diagnostic use.

SOLT (short, open, load and through) calibration

All vector network analyzers need to reference their measurements to well-known standard networks. These need to provide a wide dynamic range of amplitude and phase (or delay time) so that measurements between the given extremes become calibrated. PicoVNAs support SOLT calibration of transmission and reflection, whereby the short, open and through provide known and opposing extremes of phase, high-scale amplitude and transmit isolation. The load provides known low-scale reflect amplitude and transmit isolation. For Pico calibration standards these are all fully and traceably S-parameter characterized.

TRL and TRM (through, reflect, line and match) calibration

This is theoretically accurate because a machined air transmission line can be fabricated more precisely than a good match can be measured; certainly at higher frequencies. As this line standard can also carry the burden of time (phase) calibration, the additionally needed high-reflection standards, the shorts or opens, can also be less well known.

TRL technique requires a line length of significantly more than 0° phase delay and significantly less than 180° . Thus, a single TRL line can only address a limited frequency band. The PicoVNA 108 supports one or two TRL bands and can account for line impedance offset if required. A low-frequency TRM band can reference a readily fabricated resistive match.

TRL and TRM calibration are popular choices when measuring substrate-mounted DUTs, for example surface-mounted networks or components. The line, match and reflections (shorts and opens in the PicoVNA case) can all be readily fabricated on substrate and at precise on-substrate measurement reference planes.

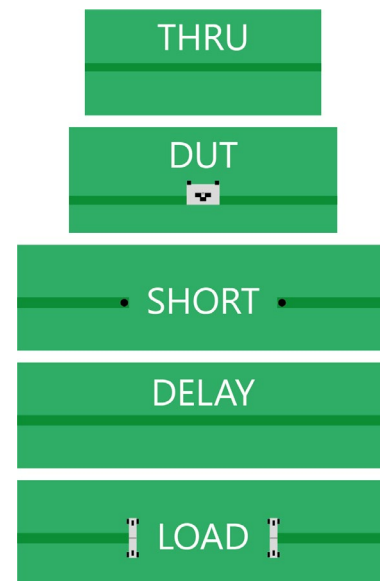

Flexible measurement insight using PicoVNA 3 software

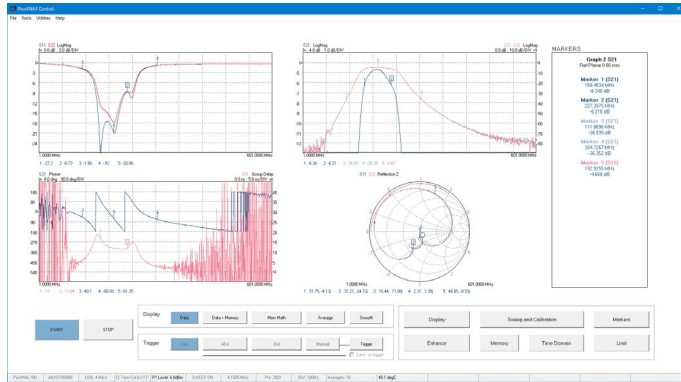

Graph 2 S21
Ref Plane 0.00 mm

- Marker 1 (S21)
158.4534 MHz
-6.340 dB
- Marker 2 (S21)
227.3975 MHz
-6.210 dB
- Marker 3 (S21)
111.8696 MHz
-36.935 dB
- Marker 4 (S21)
304.7267 MHz
-36.352 dB
- Marker 5 (S12)
192.9255 MHz
-4.668 dB

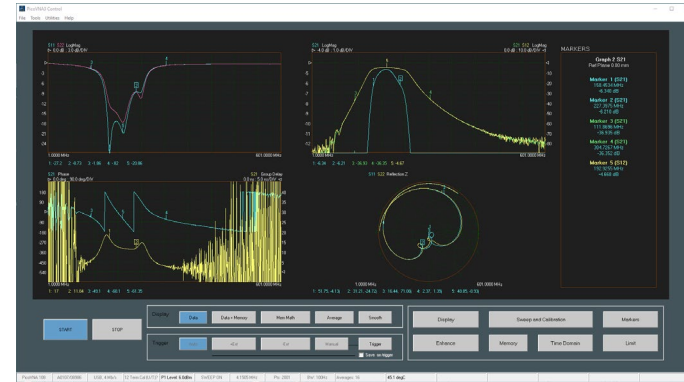

The PicoVNA 3 software and GUI interfaces with the VNA over USB 2.0 and displays or exports measurement results. MS Windows display, in default or dark theme, presents up to four user configurable plot channels, with dual y-axis cartesian, polar or Smith plots, each supporting up to four live and four memory traces and eight measurement markers. Marker results are tabulated to the right and summarized below each plot to give at-a-glance understanding of the networks under test. Y-axis reference, scalings and offset are click and drag or type editable.

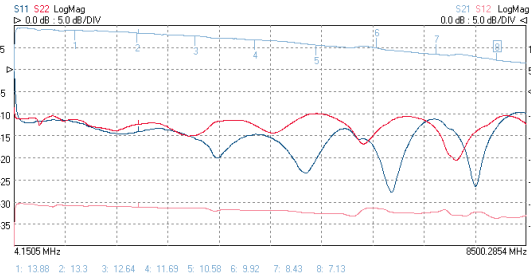

Show all S-parameters separately or combine on a single plot. Configure as one, two or four channels and show one to four live traces on each. Add one to four memory traces to each.

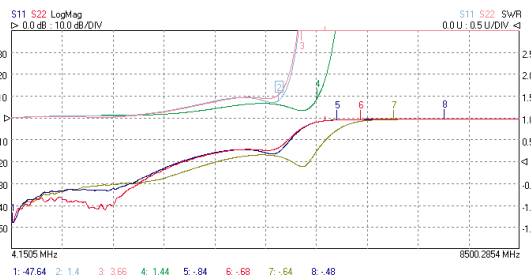

Plot both reflection parameters (S_{11} , S_{22}) as LogMag and SWR. Two of four memory traces in use to compare another DUT.

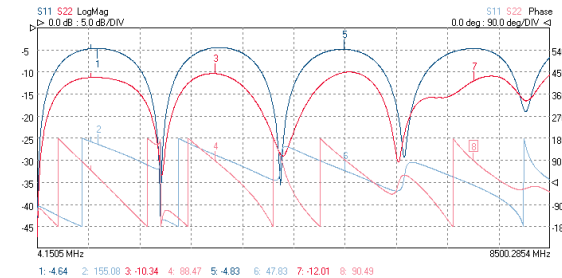

Plot both reflection parameters (S_{11} , S_{22}) as LogMag and Phase. Gain and phase can be combined in one plot, but with up to four live traces, why not plot forward and reverse match and gain and phase together, as above?

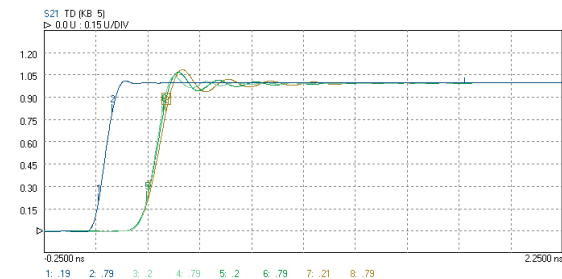

Compare network pulse responses using S_{21} time domain. Here using a live trace and up to four memory traces to compare low pass filter responses with through response.

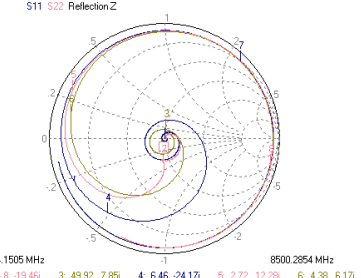

Show S_{11} and S_{22} on the same Smith chart. Add up to four memory traces if required.

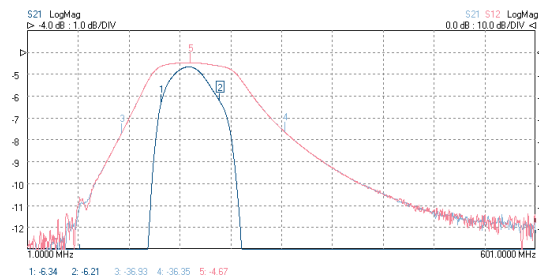

Display a single parameter at two sensitivities or offsets. Here we see passband S_{21} flatness and S_{21}/S_{12} stopbands as live traces on the same plot.

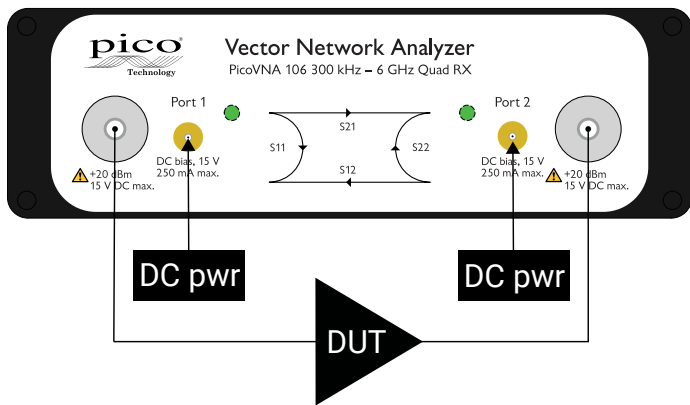

Use bias-Ts to power an active DUT

Other I/O

Power (12 to 15 V DC, 25 W) and USB 2.0 control are located on the rear panel. Trigger I/O for sweep synchronization and 10 MHz I/O for reference clock synchronization are available on four BNC sockets.

Bias-Ts

Bias-Ts are often not provided, or available as costly extras, on other VNAs. Use the PicoVNA's built-in bias-Ts to provide a DC bias or test stimulus to active devices without the complexity and cost of external DC-blocks. The bias is supplied from external power supplies or test sources routed to the SMB connectors next to each VNA port.

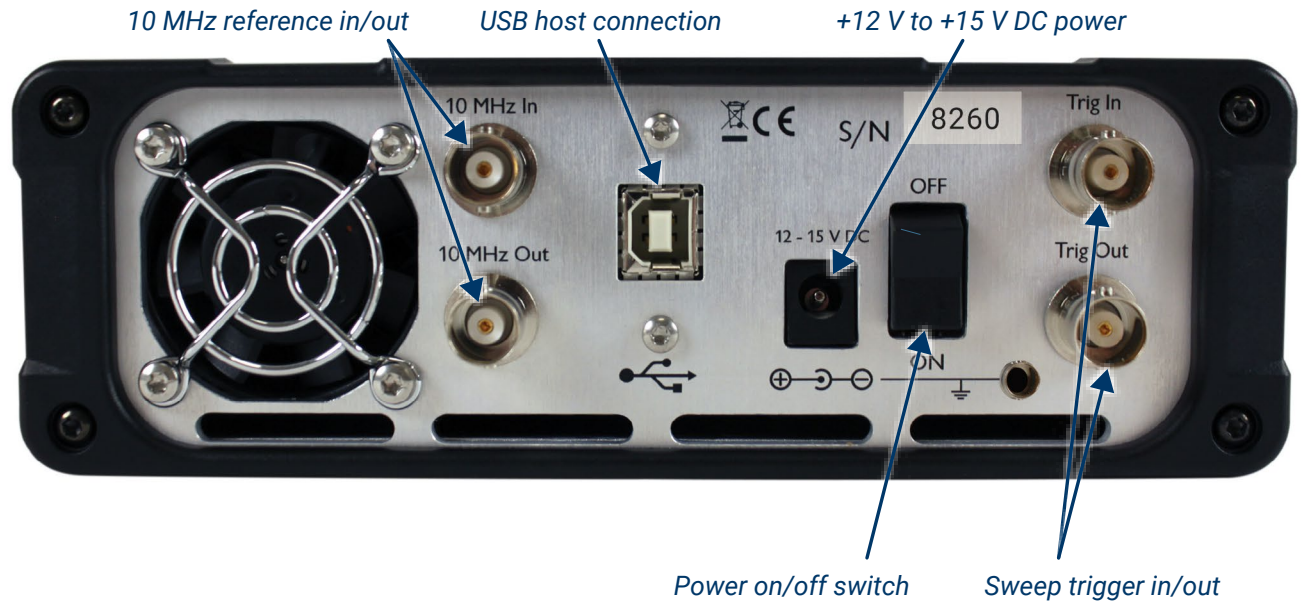











Test cables, adaptors, calibration standards and measurement check standards

A range of high-integrity RF and microwave accessories are available from Pico Technology. Test cables and calibration standards strongly influence the overall performance of a VNA, so we recommend that you select your accessories and perform your calibrations carefully.

Cables and standards are often the weakest links in a VNA measurement, generally contributing significantly to measurement uncertainty despite their traditionally high cost. At the lowest levels of uncertainty, costs can be significant and measurements can be compromised by seemingly quite minor damage or wear. For these reasons, many customers hold both premium-grade items for calibration, reference or measurement standards, and standard-grade items as working standards and cables. Pico Technology now offers cost-effective solutions in both grades. In general we recommend PC3.5 interfaces for premium or reference use and SMA interfaces for working use.

Phase- and amplitude-stable test leads and test port adaptors

Two test cable types and grades are recommended and provided by Pico Technology. Both of high quality, with robust and flexible construction and stainless steel connectors, the main differences between them are the provision of PC3.5 or SMA test ports and the stability of their propagation velocity and loss characteristic when flexed; that is, the degree to which a measurement could change when the cables are moved or formed to a new position. Cables are specified in terms of flatness and phase variation at up to 8.5 GHz when a straight cable is formed as one 360° turn around a 10 cm mandrel.

Order code		Grade	Dielectric	Diameter	Impedance	Loss	Phase stability	Amplitude stability	Length	Connectors
TA336		Standard	Low-density PTFE	7.1 mm (0.28") over jacket	50 Ω	0.7 dB at 6 GHz 0.85 dB at 8.5 GHz	2° at 6 GHz 2.8° at 8.5 GHz	0.1 dB at 6 GHz	600 mm	N(m)-SMA(m)
TA337										N(m)-SMA(f)
TA338		Premium	7.5 mm (0.30") over jacket	50 Ω	0.6 dB at 6 GHz 0.7 dB at 8.5 GHz	0.8° at 6 GHz 1.1° at 8.5 GHz	0.05 dB at 6 GHz	N(m)-PC3.5(m)		
TA339								N(m)-PC3.5(f)		
Order code		Grade	Name	Impedance	Bandwidth				Connectors*	
TA342		Standard	ADA-STD-MM	50 Ω	18 GHz				SMA(m-m)	
TA343			ADA-STD-FF						SMA(f-f)	
TA357			ADA-STD-FM						SMA(f-m)	
TA340		Premium	ADA-PREM-MM	50 Ω	27 GHz				PC3.5(m-m)	
TA341			ADA-PREM-FF						PC3.5(f-f)	
TA354			ADA-PREM-FM						PC3.5(f-m)	





Calibration and measurement reference standards

Pico Technology offers a range of short, open, load and through (SOLT), 4-piece, 5-port manual calibration kits in male and female genders. All kits have high-performance, tight-tolerance stainless steel interface connectors and are supplied as an assembled five-port “Y” SOLT. They can be disassembled for individual usage, or for economical refurbishment should a calibration standard be damaged. Each SOLT is supplied with calibration data linked to the kit serial number.

Both the Standard and Premium kits offer exceptional residual directivity for the price. It is this that combines with good uncorrected port match on the PicoVNAs to deliver exceptional price-performance.

Premium PC3.5 kits are calibrated to reduced uncertainty using TRL intercomparison above 1.5 GHz.

* SMA, PC3.5 and K-type/2.92 connectors can all be mated with each other. SMA type has solid dielectric, PC3.5 has air dielectric.



Order code		Name	Type	Ports	Impedance	Connector*	Characterization*
TA344		SOLT-STD-M	Standard manual SOLT	5 (short, open, load, through)	50 Ω	SMA(m)	Full S-parameter 300 kHz to 8.5 GHz. Serial-numbered .kit file provided on USB memory stick.
TA345		SOLT-STD-F				SMA(f)	
TA346		SOLT-PREM-M	Premium manual SOLT			PC3.5(m)	
TA347		SOLT-PREM-F				PC3.5(f)	

Automated E-Cal USB-controlled and ovened calibration standards

Minimized as far as possible, the manual calibration process involves several torqued connect/disconnect operations and a manual loading of unique data files for each standard. The E-Cal SOLT calibration process reduces this to just one connection by internally switching its calibration standards. The process becomes automatic and highly repeatable, with power, control and data read all managed by the PicoVNA software over a USB interface.

Fast, convenient and less error-prone, an E-Cal standard is to an extent compromised by switch errors, resulting in non-ideal short, open, load and through. Mitigating this, the PicoVNA E-Cal standards include fast-rise oven control of device temperature, and seventeen traceable, full span s-parameters characterize the now stable imperfections. It is also true that the convenience, de-skilling and speed of automated calibration tend to promote more regular calibration, and thus more accurate, repeatable and reliable measurement – so much so that some process managers insist upon an automated E-Cal.

All PicoVNA calibration and check standards (below) are calibrated against fully traceable PC3.5 standards and are supplied in a protective carry case. Further specifications for the instrument and calibration kits can be found on later pages. We also offer a calibration service for Pico standards: see *Ordering information*.

Order code		Name	Type	Ports	Standards	Impedance	Connector*	Characterization
TA518		SOLT-AUTO-M	Ovened USB-controlled automated E-Cal SOLT	2	Short, open, load, through and separate characterized/polarized port adaptor	50 Ω	SMA(m)	Full S-parameter 300 kHz to 8.5 GHz. Embedded and read from USB device
TA519		SOLT-AUTO-F					SMA(f)	





Check standards

We offer two economical check standards that can be used to validate the accuracy of a network analysis test setup and its calibration before and during or after measurements are made. Akin to the Beatty line, each check standard is a short length of mismatched line (75 mm of 25 Ω) with a predictable, smooth and stable mismatch and transmission characteristic that spans the frequency range of the PicoVNAs. These devices validate system measurement accuracy in the presence of high and varying mismatch and thus present a demanding validation on which to base confidence in a setup.

A comparison utility is provided in the PicoVNA 3 software (described on later pages) to evaluate the comparison against a combination of specified measurement uncertainties for the device, test leads and instrument. Each check standard is supplied with Touchstone measurement data on USB memory stick. The data is traceable via PC3.5 standards to national standards. The supplied Touchstone measurement data is compatible with, and can be used to manually validate a measurement of, any manufacturer's VNA.

Two check standards are available: insertable SMA(m-f) and noninsertable SMA(f-f).

Order code		Name	Type	Ports/ Standards	Interface/ Impedance	Characterization	Supported calibration modes
TA430		CHK-INS-MF Insertable with a male and a female port	Check standard	2 ports/ 25 Ω low-impedance line with transition to 50 Ω ports	SMA(m) / 50 Ω	Full S-parameter 300 kHz to 8.5 GHz. Serial-numbered Touchstone file provided on USB memory stick	Insertable 12-term calibration, all S-parameters
TA431		CHK-NON-F Noninsertable with female ports			SMA(f) / 50 Ω		Non-insertable, known and unknown through calibrations, all S-parameters

Please see *Software description* and *Specifications* for further details.

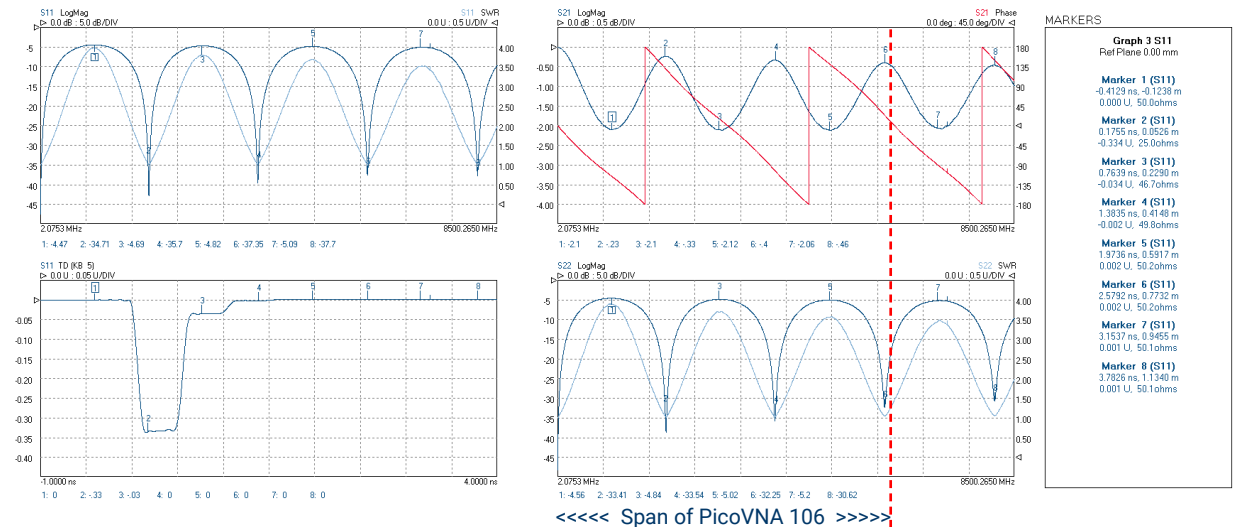

S-parameter and time-domain plots for TA431 over an 8.5 GHz span.
Minor but within-specification S_{21} measurement errors present.

Test cables and calibration standards selection guide

Calibration kits can be purchased as a pair or as a single kit depending on the primary (best uncertainty) measurement application and its DUT interface, and sometimes to meet a secondary purpose with other DUT interfaces. Budget may also be a consideration. Pico Technology provides for all purchase options. You can order any combination of accessories, but to get you started we recommend that you choose one of the following 'universal' configurations.

Recommended configurations using manual SOLT calibration standards

For best overall test efficiency and uncertainty in a mix of single-port or dual-port test applications of both genders, we recommend these dual-port test lead and calibration standards configurations and the use of test port adaptors as necessary. All calibration modes are then available and where needed port adaptors can be fully included in the calibration.

Primary DUT interface	Select accessory grade	Required test leads	Required manual SOLT calibration kits	Supported measurement and calibration modes	Port adapt for some DUTs...
"Universal" capability. Dual-port devices or any single-port device with male or female or male and female ports	Standard SMA	1x TA336 SMA male port 1x TA337 SMA female port	1x TA344 SMA male ports 1x TA345 SMA female ports	All single and dual-port calibration modes and S-parameters	To address dual-port single-gender non-insertable devices, use and include within calibration 1x TA342 SMA(m-m) or TA343 SMA(f-f) test port adaptor.
	Premium PC3.5	1x TA338 PC3.5 male port 1x TA339 PC3.5 female port	1x TA346 PC3.5 male ports 1x TA347 PC3.5 female ports		To address dual-port single gender non-insertable devices, use and include within calibration 1x TA340 PC3.5(m-m) or TA341 PC3.5(f-f) test port adaptor.

The following configurations use just one SOLT calibration standard and are recommended where there is a focus on a particular port gender.

Primary DUT interface	Select accessory grade	Required test leads	Required manual SOLT calibration kits	Supported measurement and calibration modes	Port adapt for some DUTs...
Single port or dual-port noninsertable with female port(s)	Standard SMA	2x TA336 SMA male port*	1x TA345 SMA female ports	All S-parameters and all single and dual-port calibration modes except insertable	Note that mixed gender dual-port insertable devices can be addressed by adding and de-embedding 1x TA341 PC3.5(f-f) or TA343 SMA(f-f) test port adaptor**.
	Premium PC3.5	2x TA338 PC3.5 male port*	1x TA347 PC3.5 female ports		
Single port or dual-port noninsertable with male port(s)	Standard SMA	2x TA337 SMA female port*	1x TA344 SMA male ports		Note that mixed gender dual-port insertable devices can be addressed by adding and de-embedding 1x TA340 PC3.5(m-m) or TA343 SMA(m-m) test port adaptor**.
	Premium PC3.5	2x TA339 PC3.5 female port*	1x TA346 PC3.5 male ports		

* Can reduce to a single test lead in single-port measurement applications.

** With only one calibration kit it is not possible to calibrate after port gender adaptation. Purchase a second calibration kit of opposing gender for full calibration of a port adaptor. Alternatively, once a noninsertable calibration has been performed, it is possible to measure the port adaptor(s) and de-embed their error. A third option is to use reference plane shift and/or normalization for a lesser correction of adaptor errors.

Recommended configurations using automated E-Cal SOLT calibration standards

Primary DUT interface	Select accessory grade	Required test leads	Required manual calibration kits	Supported measurement and calibration modes	Also suited to DUTs...
"Universal" capability. Dual-port devices or any single-port device with male or female or male and female ports	Standard SMA test leads	2x TA336 SMA male port 2x TA343 SMA(f-f) port adaptor	1x TA518 SOLT-AUTO-M and 1x TA519 SOLT-AUTO-F*	All dual-port calibration modes and S-parameters	Use and include within calibration: 1) A test port adaptor to address insertable dual-port devices**. 2) Both port adaptors to address dual male port non-insertable devices.
	Premium PC3.5 test leads	2x TA338 PC3.5 male port 2x TA341 PC3.5(f-f) port adaptor			
Alternatively using 1x automated E-Cal calibration standard ...					
Dual-port non-insertable devices or any single female port device	Standard SMA test leads	2x TA336 SMA male port 1x or 2x TA343 SMA(f-f) adaptor	1x TA519 SOLT-AUTO-F	All dual-port calibration modes and S-parameters	Use and include within calibration a test port adaptor to address insertable dual-port devices or single-port device of opposing gender**. Note that opposing gender dual-port non-insertable devices can be addressed by adding and de-embedding a further port adaptor***.
	Premium PC3.5 test leads	2x TA338 PC3.5 male port 1x or 2x TA341 PC3.5(f-f) adaptor			
Dual-port non-insertable devices or any single male port device	Standard SMA test leads	2x TA337 SMA female port 1x or 2x TA342 SMA(m-m) adaptor	1x TA518 SOLT-AUTO-M	All dual-port calibration modes and S-parameters	Use and include within calibration a test port adaptor to address insertable dual-port devices or single-port device of opposing gender**. Note that opposing gender dual-port non-insertable devices can be addressed by adding and de-embedding a further port adaptor***.
	Premium PC3.5 test leads	2x TA339 PC3.5 female port 1x or 2x TA342 SMA(m-m) adaptor			

* This automated dual E-Cal SOLT configuration is available with discount. Please see TA520 on the ordering information page.

** To calibrate use the characterized and polarized through adaptor supplied with your E-Cal standard. The PicoVNA E-Cal calibration wizard guides this setup.

*** With only one calibration kit it is not possible to calibrate after two-port gender adaptations. Purchase a second E-Cal calibration kit of opposing gender for full calibration after two-port adaptations. Alternatively, once a non-insertable calibration has been performed, it is possible to measure the second port adaptor and de-embed its error. A third option is to use reference plane shift and/or normalization for a lesser correction of adaptor errors.

6 GHz Network Metrology Training and Metrology Kits

The low-cost PicoVNA 106 opens up the potential for every student or trainee to learn through the use of a full-function professional-grade vector network analyzer. The Pico PQ186 Network Metrology Training Kit builds on this opportunity and supports a wide variety of learning and experiment. Central to the kit is the separately available PQ189 Network Test PCA. This printed circuit accessory hosts a variety of example lumped element, active and passive and transmission line DUTs and end-of-line SOLT (short-open-load and through) calibration standards.

Used with the PicoVNA 106 or 108, the kit supports teaching objectives around reflection and transmission measurements, S-parameters and other standard measurement quantities. These can be presented and interpreted as log, linear, phase, real, imaginary, polar and Smith chart formats and derived quantities group delay and time domain transmission and reflection. Additionally, by including an active broadband amplifier element (+5 V DC power required, 2.1 mm jack), nonlinear compression measurements such as P1dB and AM to PM (phase due to amplitude modulation) can be explored using the PicoVNA 106's built-in measurement utilities.

Measurements and calibrations are made via industry-standard SMA connectors. These support measurements out to 6 GHz and the teaching of best interconnection practice and the importance of secure, repeatable and robust connections. Using the on-board calibration standards the student can practice calibration for reflection, transmission and 8- and 12-term corrections using short-open-load and the known and unknown through methods.

Also included in the kit is a set of budget SMA(f) SOLT calibration standards (PQ190). With these the student can calibrate at cable ends rather than on board. This supports teaching and experiment around reference plane shift, normalization and the de-embedding of feedlines and connections on the PCA. Assumed 'ideal' and typical calibration data for these standards can be downloaded from picotech.com, along with the comprehensive user's and trainer's guide and referenced instrument settings files. Students with access to the AWR Design Environment can also download the Microwave Office design project for the kit PCA. Pico's Cadence AWR DE interface wizard can then import real-world measured data directly to the project to allow measurement enhanced simulation or comparison with the design simulations. Software development kit examples are also available via GitHub (github.com/picotech) to import and work with measured data in other CAD, test and programming environments such as MATLAB, LabVIEW, C, C#, C++ and Python.

The Pico PQ186 Network Metrology Training Kit includes N(m) to SMA(f) inter-series adaptors, SMA(m-m) test leads and fixed SMA wrenches – all that the student will need to pair with the PicoVNA 106 (or any other VNA) to begin their practical learning. Printed circuit layout of the network test PCA is generic to support modification to alternative passive network and components.



PCA includes example attenuator, broadband amplifier, 25 Ω mismatched line, resistive power divider, lowpass and bandpass filters and a user chip component site, plus short, open, load and through calibration elements.

Network Metrology Demonstrator Kits

Two Network Metrology Demonstrator Kits are also offered. These include Pico's now widely respected Standard SMA or Precision PC3.5 professional-grade test leads, a female SOLT calibration kit and an SMA non-insertable female-to-female Check Standard; both with reference data, traceable back to national standards. Either of these kits can realise and verify the full measurement capability and accuracy of the PicoVNA 106 or 108. High-quality, low-uncertainty measurements can then be made, suiting this training investment to much wider application within research and doctorate projects. Accurate measurement can also establish accurate reference and error terms in the measurements that students are making when using the PQ186 Network Metrology Training Kit.



PQ187

Order code	Description	Notes	USD*	EUR*	GBP*
PQ186	Network Metrology Training Kit and carry case	<i>Incl: PQ189 training PCA, PQ190 SMA(f) training SOLT kit, 2x N(m)-SMA(f) inter-series adaptor, 2x TA312 60 cm SMA(m-m) test lead, TA177 SMA wrench.</i>	889	759	629
PQ189	Network Metrology Training printed circuit accessory and carry case		509	429	359
PQ187	Network Metrology Leader Standard kit SMA(f) and carry case	<i>Incl: 2x TA336 N(m)-SMA(m) standard test lead, TA345 SMA(f) SOLT calibration kit and data, TA431 SMA(f-f) non-insertable check standard and data</i>	1855	1575	1305
PQ188	Network Metrology Leader Premium Kit PC3.5(f) Demonstrator kit and carry case	<i>Incl: 2x TA338 N(m)-PC3.5(m) premium test lead, TA347 PC3.5(f) SOLT calibration kit and data, TA431 SMA(f-f) non-insertable check standard and data</i>	3125	2655	2195
PQ190	Network Metrology Low Cost SOLT Kit SMA(f)	<i>Typical .kit data can be downloaded</i>	105	89	75
PS011	+ 5 V DC plug top AC power supply and international adaptors		30	25	21

* Prices correct at time of publication. Sales taxes not included. Please contact Pico Technology for the latest prices before ordering. All part-numbered items separately available.

Computer-aided design partners

Antenna matching with Optenni Lab CAD software

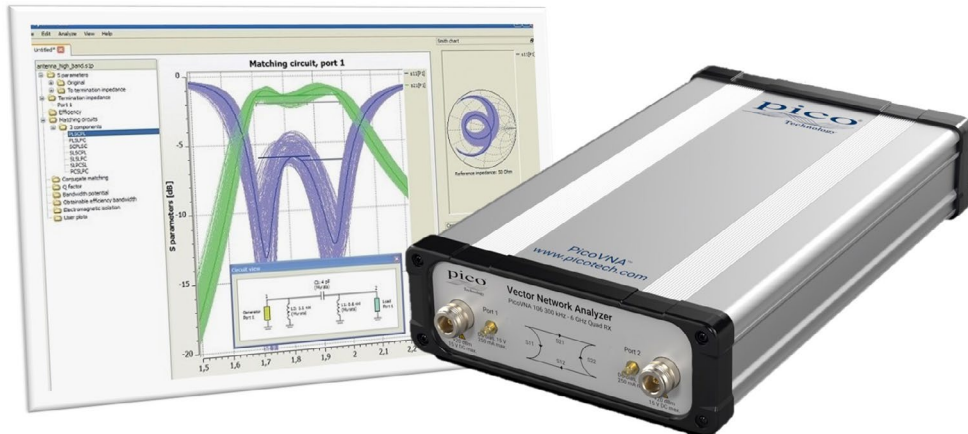

IoT, 5G, WiFi, V2X – has there ever been a bigger market explosion than the use of the antenna, and use within very challenging locations? Optenni Lab is industry-leading RF design automation software for antenna matching and RF chain performance optimization. The tool addresses multi-band, broadband, multi-antenna and tunable antenna systems and synthesizes measurement-based matching solutions in real time. In other words, Optenni Lab outputs optimized matching circuits based on live vector network analyzer measurements of antennas. Optenni Lab versions from 4.3 SP5 are compatible with the PicoVNA. The tool synthesizes optimal topologies from discrete, distributed, variable or switched component libraries against desired bandwidth and isolation targets, taking into account mutual coupling to nearby antennas. Optenni Lab automatically outputs highly complex and normally time-consuming designs. This CAD software interfaces the PicoVNA control DLL directly and no further software is required.

Cadence AWR Connected for PicoVNA

The AWR Connected wizard for the PicoVNA brings affordable vector network measurement right into the Cadence AWR Design Environment. Component, system and subsystem measurements are available, controllable and displayed inside your simulation workspace. Real-world measurements become available for one-click transfer directly to project data files – that you can use within your simulations or for direct plot and comparison.

Design–Simulate–Implement–Measure workflow is encapsulated in a single design environment, tightly coupled for optimized speed and efficiency.

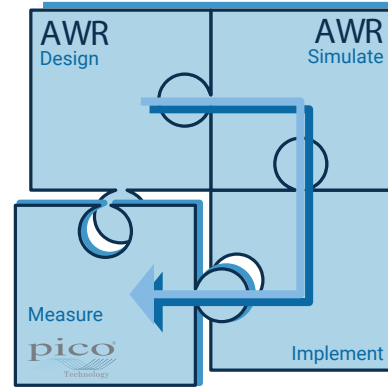

Features at a glance

- Control and view PicoVNA output inside your design environment
- One-click measurement transfer to new or existing project data files or plots
- Fast, convenient comparison of ideal, modeled and measured component data
- Simulation with measured component or subsystem data
- Extend measured data to 0 Hz for passive component simulation at DC
- Measure and plot active max. stable gain, available gain, K-factor and B1

Powerful education and training alliance

Can there be any more effective and rewarding learning experience than completing the whole design cycle? Unfortunately, the high costs of microwave network measurement have for many compromised that experience in the classroom. We believe that the more affordable PicoVNA 106 6 GHz full-function, professional-grade vector network analyzer, partnered with Microwave Office, changes the game.

Designed within Microwave Office, the PCB project design file is available to download. Students and trainers can engage at any point in the design cycle, compare simulation with real measurement, and experiment within the simulated and real environments.

How it works

1. Start the PicoVNA wizard to launch the PicoVNA control software and establish control of the PicoVNA.
2. From the **PicoVNA** tab select your saved calibration and measurement settings. Select single or dual port import and preferred preview plots.
3. Save Touchstone from here if required.

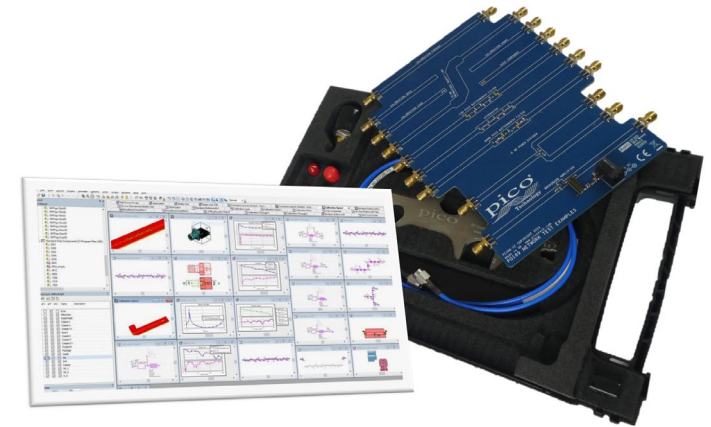

Microwave Office project file for the Network Metrology Test kit

4. From the **MWO Datafile** tab, select or create a project data file to receive your measured data.
5. One click creates or updates your data.

6. Optionally use the **Passive Component** or **Transistor** data tabs to create or update parameter graph plots with one click.

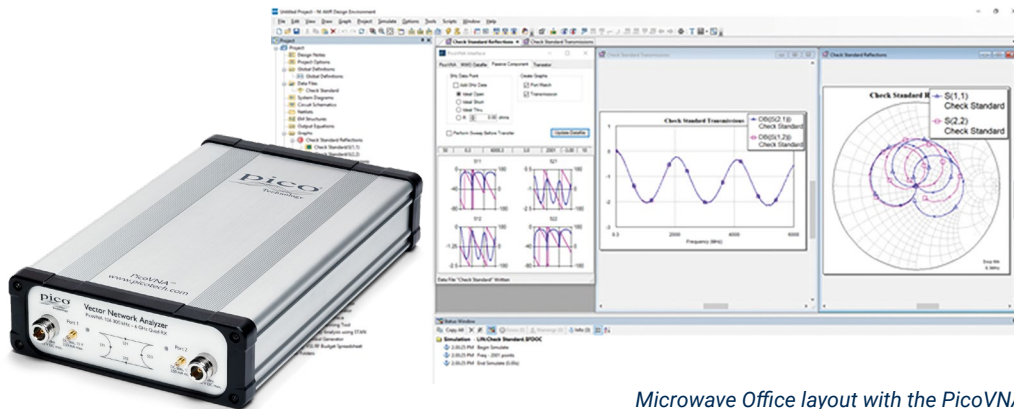

Microwave Office layout with the PicoVNA wizard (2nd panel) in the workspace

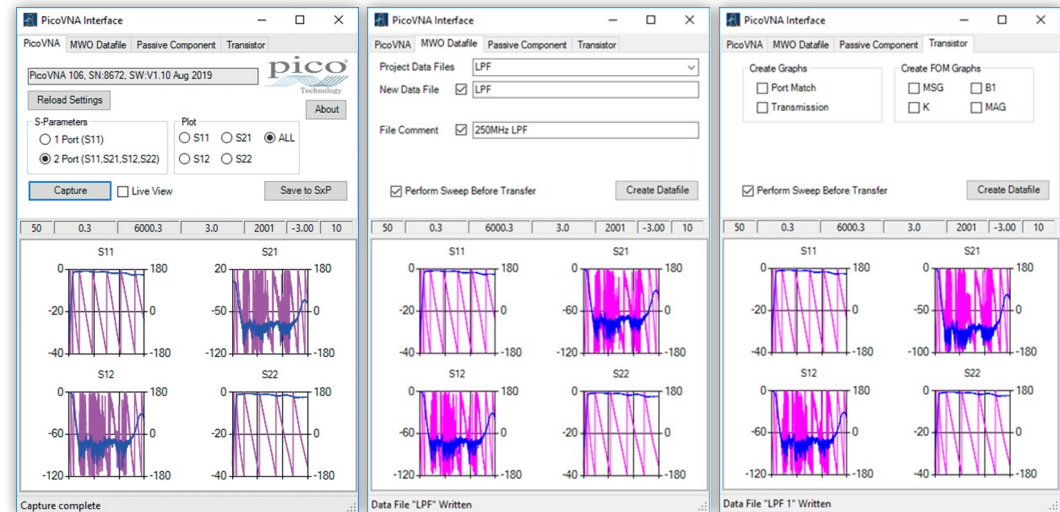

PicoVNA 3 software

PicoVNA 3 software presents VNA measurement and calibration simply, intuitively and with efficient usage at its heart. The software offers a comprehensive range of measurements and multiple trace, dual-axis plot formats in one, two or four user-configurable display channels. All the standard vector network analyzer functions and tabulated measurements can be seen at a glance.

Import / export, help and utilities

Save, recall, print, labels and calibration tools
 P1dB, AM to PM, signal generator and compare data utilities
 PicoVNA 108 only: Save on trigger, mixer measurements and phase meter

S_{11}/S_{22} - parameters being plotted

LogMag - measurement type/unit
 ▷ - reference position indicator
 0.0 dB - reference level
 5.0 dB/DIV - sensitivity

Axis parameters

Display two Y-axis parameters per graph

Direct access to channel settings

Click or touch, drag or type values, reference position, scalings and markers

Display formats

One, two or four channels

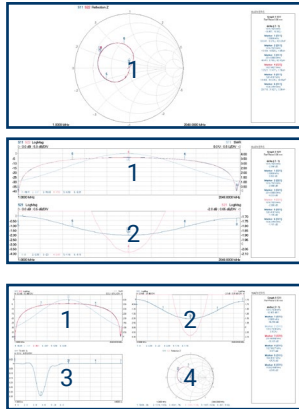

Plot formats

- Log magnitude
- Phase
- Smith chart
- VSWR
- Group delay
- Linear magnitude
- Real
- Imaginary
- Time domain
- Polar linear

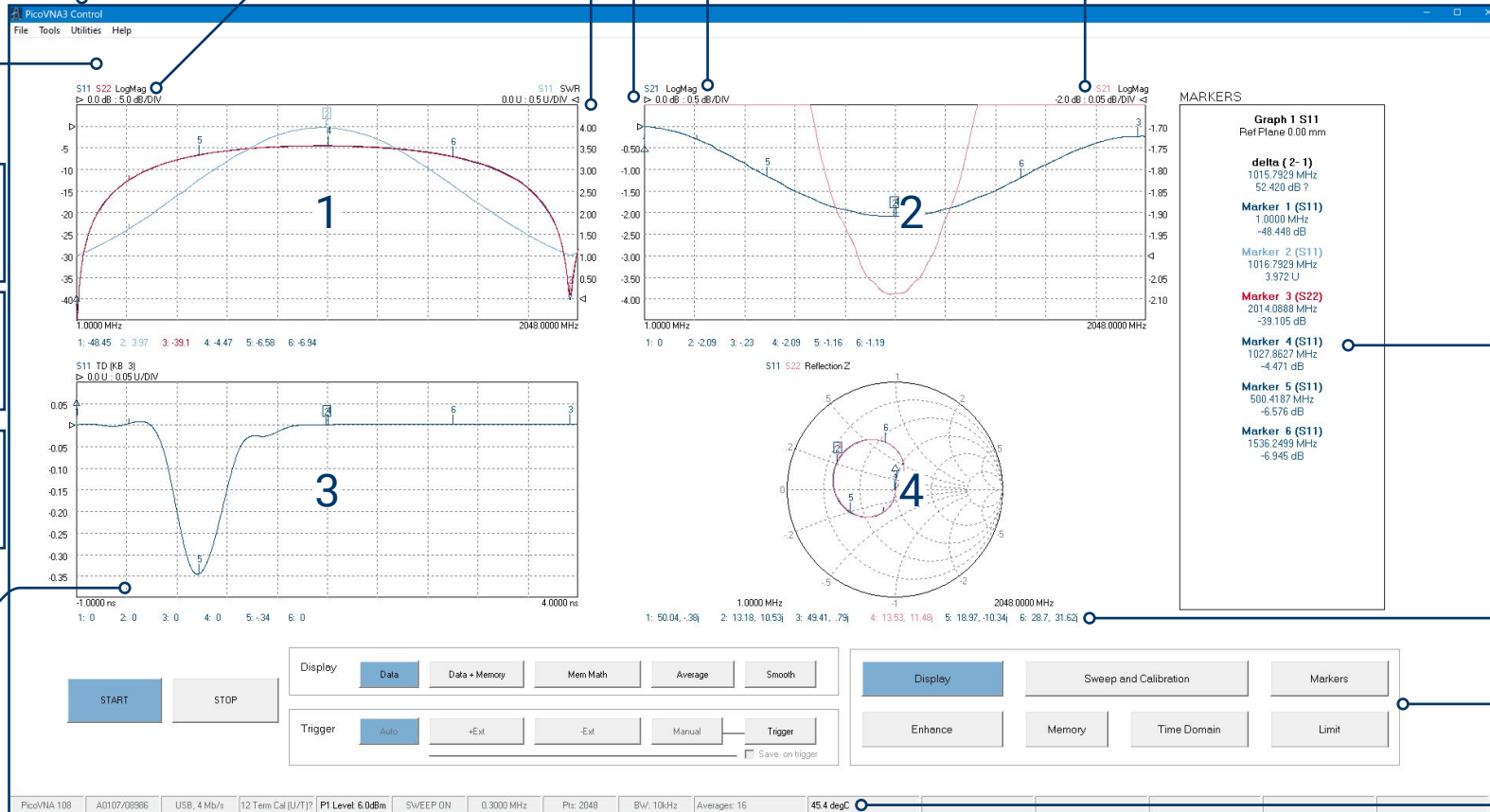

Marker readouts
 Table of up to eight markers for the selected channel in trace color.

Marker summary

User interface

Controls, instrument and status information, trigger and vector trace math functions information and vector trace math functions.

Illustrated use of display channels and Y-axes

1. Two live update parameters (S_{11} and S_{22}), plotted log magnitude (left axis) and SWR (right axis)
2. One live parameter (S_{21}), plotted Log Magnitude at 0.5 dB/div (left axis), and 0.05 dB/div and -2.0 dB offset (right axis)
3. One live parameter (S_{11}), plotted Time Domain (impedance by time or distance)
4. Two live parameters (S_{11} and S_{22}), plotted as Smith Chart

Reference plane extension

Reference plane extension (offset) allows you to shift the measurement reference plane away from the point established during calibration. This is useful in removing the path length of assumed ideal connectors, cables or microstrip lines from measurements. PicoVNA 3 software allows independent reference plane extensions on each of the measurement parameters (S_{11} , S_{22} , S_{12} or S_{21}), either as an automatic re-reference or by manual entry. Independent extensions allow, for example, different extensions on the two ports for S_{11} and S_{22} and then through-line normalization for S_{21} and S_{12} transmission comparison with equivalent length through-line.

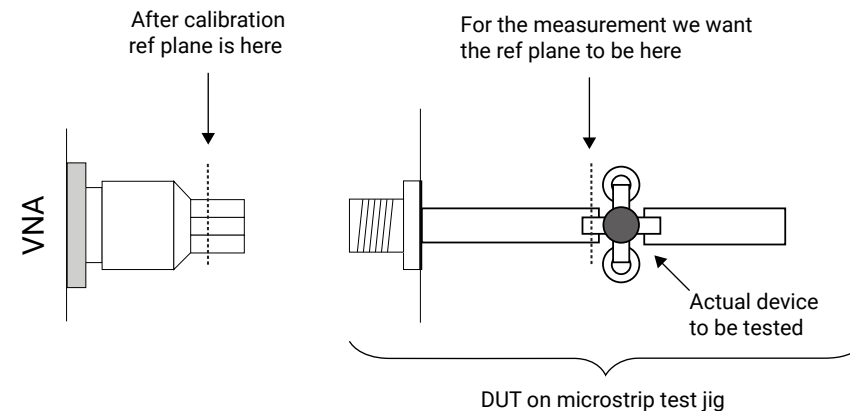

De-embedding embedded port interfaces

When it is unsafe to assume the above ideal interconnecting connectors cables or microstrip lines; for example to achieve greater accuracy or to remove known imperfections in a test setup, we can choose instead to de-embed the interface networks on each measurement port. The PicoVNA software simply requires a full Touchstone .s2p file for the embedded interfacing network on each port. Likewise, defined networks can be embedded into the measurement to achieve a desired simulated measurement. As for a calibration, best accuracy will be achieved when the embedding network is defined at the same frequency points as the intended measurement. Unusually for a vector network analyzer, the PicoVNA software will interpolate where necessary and possible.

Time-domain transmission and reflectometry measurements

Time-domain reflectometry is useful in the measurement of a transmission line or component; in particular the distance-to-fault location of any discontinuity due to connectors, damage or design error. To achieve this, the PicoVNA software determines from its frequency-domain measurements the time-domain response to a step input. Using a sweep of harmonically related frequencies, an inverse fast Fourier transform of reflected frequency data (S_{11}) gives the impulse response in the time domain. The impulse response is then integrated to give the step response. Reflected components of the step, occurring at measurable delays after excitation, indicate the type of discontinuity and (assuming a known velocity of propagation) the distance from the calibration plane.

A similar technique is used to derive a TDT (time-domain transmission) signal from the transmitted signal data (S_{21}). This can be used to measure the pulse response or transition time of amplifiers, filters and other networks.

The PicoVNA software supports Hanning and Kaiser–Bessel lowpass filtering on its time-domain IFFT conversions, preserving magnitude and phase, and achieving best resolution. Marker readouts include magnitude, time, distance and line impedance in ohms. A DC-coupled DUT is essential to the method. The 8.5 GHz bandwidth of the PicoVNA 108 supports time-domain pulse transition times down to 58.8 ps, with the PicoVNA 106 reaching 82.7 ps.

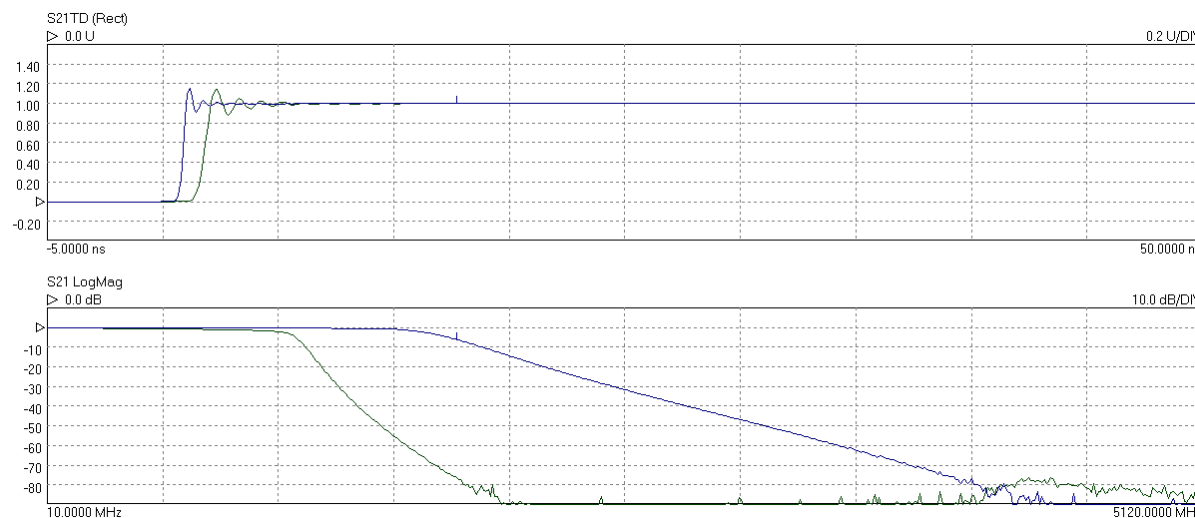

Time domain transmission step responses (top) and frequency responses (bottom) of two lowpass filters

Z₀ impedance reference

System measurement impedance (default 50 Ω) can be mathematically converted to any value between 10 Ω and 200 Ω. The PicoVNA software also supports the use of external matching pads and calibration in the new impedance using a calibration kit of that impedance.

Limit lines testing

The limit lines facility allows six segments to be defined for each displayed plot. These can be extended to 11 segments using an overlapping technique. Visual and audible alarms can be given when a limit line is crossed. All plot formats except Smith chart and polar support limit testing. Peak hold functions are also available.

Supported calibrations

The PicoVNA 3 software supports a comprehensive range of calibration modes to address single or dual-port workload with male, female or mixed gender interfaces, all with best achievable accuracy (least uncertainty). In some instances only a single calibration kit may be required, as has been outlined above.

As you would expect, the Pico calibration kits are individually serial-numbered and supplied with S-parameter data. This data is a traceable and accurate record of measured errors for the calibration kit. It can be loaded into the software, which will correct for these errors and those of the instrument during a calibration.

Alternatively, you can use a third-party calibration kit whose 'model', electrical length, parasitic values and polynomial coefficients you can enter into the software and then save in Pico .kit format. Where a third party has supplied a calibration kit S-parameter data file, please ask us about the possibility of conversion to Pico format.

When using an automated E-Cal SOLT Standard, an extended set of traceable S-parameter data sits within the device and is read directly into the PicoVNA software over its USB control and power connection.

As for any vector network analyzer, for best accuracy a calibration is performed before a measurement with the same sweep span and frequency steps as the measurement. If, however, a change of sweep settings is necessary for a measurement, the PicoVNA software will for convenience interpolate its corrections to the new sweep settings.

An *enhanced isolation* calibration setting is available for optimum dynamic range when using resolution bandwidths below about 1 kHz.

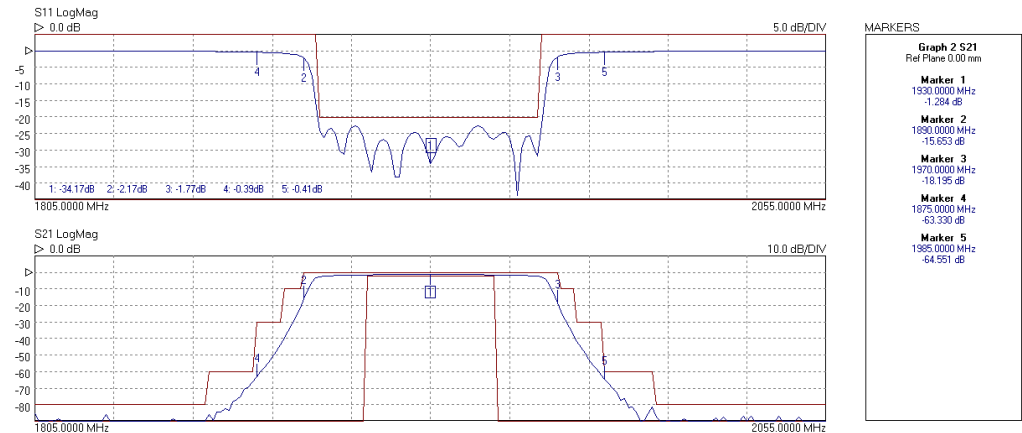

The screenshot shows the 'Calibration Kit Parameters' dialog box for two ports. Port 1 is configured with kit name 'PF00009-85' and Port 2 with 'PM00007-85'. Both ports have 'Load data available', 'Thru data available', and 'Short and Open data available' checked. The dialog includes sections for 'Kit parameters' (Female/Male selection, Loss, Open/Short offsets), 'Open capacitance coefficients' (C0-C3), 'Short inductance' (L), 'Thru length' (mm), and 'TRL Standards' (Line 1/2, FL, FH, Reflect Standard).

Port	Kit name	Load data available	Thru data available	Short and Open data available
Port 1	PF00009-85	<input checked="" type="checkbox"/>	<input checked="" type="checkbox"/>	<input checked="" type="checkbox"/>
Port 2	PM00007-85	<input checked="" type="checkbox"/>	<input checked="" type="checkbox"/>	<input checked="" type="checkbox"/>

P1dB utility

The 1 dB gain compression point of amplifiers and other active devices can be measured using a power sweep, either at a test frequency or over a sweep of test frequencies. The VNA determines the small-signal gain of the amplifier at low input power, and then increases the power and notes the point at which the gain has fallen by 1 dB. This utility uses a second-order curve fit to determine interpolated 1 dB compression points.

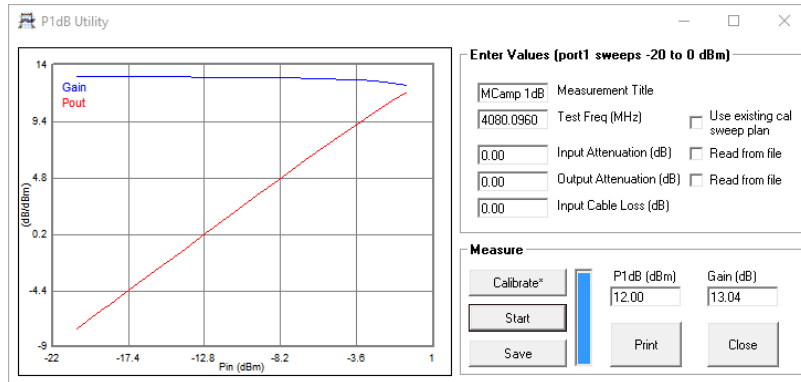

AM to PM conversion utility

AM to PM conversion is a form of signal distortion where changes in the amplitude of a signal produce corresponding changes in the phase of the signal. This type of distortion can have serious impact in digital modulation schemes for which amplitude varies and phase accuracy is important.

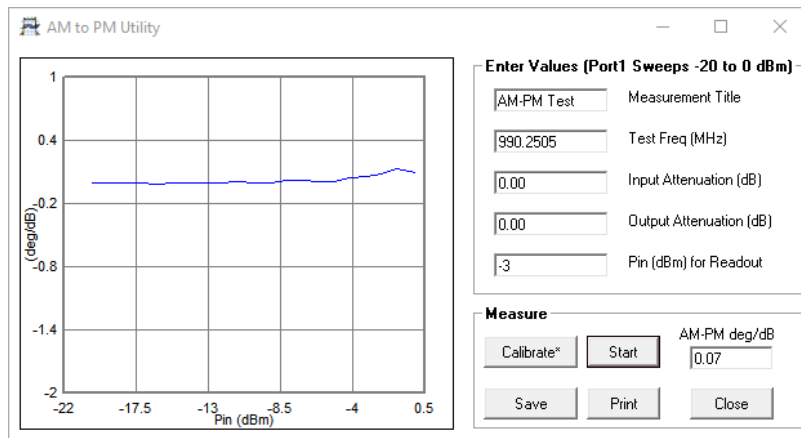

Phase meter utility (PicoVNA 108 only)

The phase meter adds a valuable phase and amplitude alignment and stability measurement capability to the PicoVNA 108. The two ports become auto-lock receivers at any user-specified frequency within the 300 kHz to 8.5 GHz tuning range of the VNA. The receivers will lock to externally applied signals within approximately ± 70 kHz of the set frequency and begin to measure and cross-refer phase and amplitude of the two signals as numerical readouts.

Calibration and normalization facilities are provided, allowing, for example, precise alignment of a quadrature-phase relationship or determination of differential phase and amplitude balance or stability.

The IF bandwidth setting determines displayed result resolution, update rate and also measurement noise at any given signal level. At IFB of 10 Hz, resolution is 0.001° and 0.001 dB and update rate around 4 readings per second. Amplitude and phase accuracies match those of standard VNA transmission measurements.

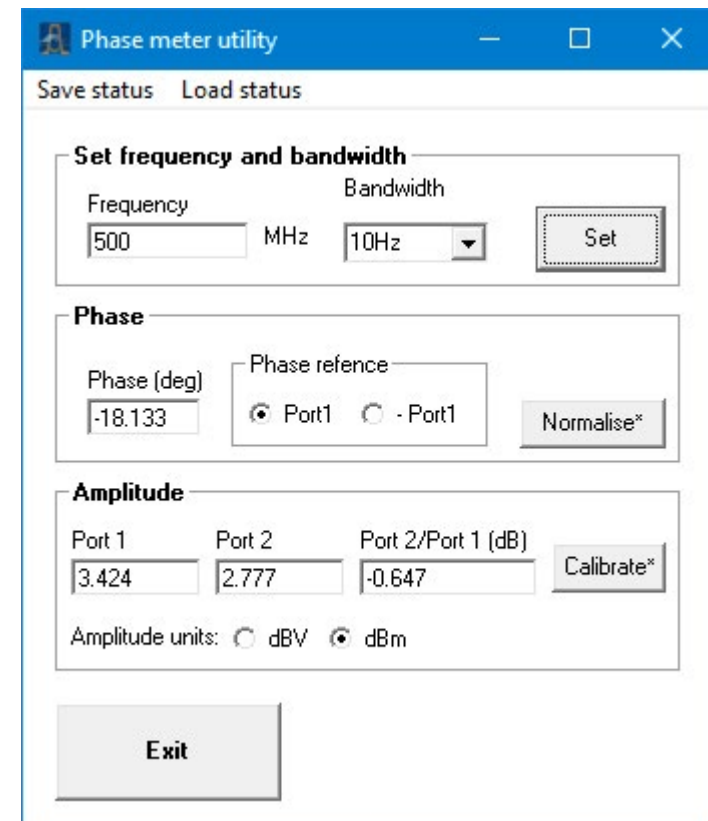

Save on trigger utility (PicoVNA 108 only)

Uniquely, benefiting from the fast measurement speed of the PicoVNA, save on trigger provides a fast and convenient method for capture and display of measurement data from multiple or changing device-under-test states. Think, for example, of variable attenuators, digitally configured filters, phase shifters or variable-gain amplifiers. Think also of devices under changing power supply, bias or environmental conditions, or even of a multiplexed measurement of a number of devices in the production environment. The PicoVNA can be set up to store up to 1024 triggered sweep measurements which can then be inspected, reordered and saved to disk in a number of formats. The trigger event can arrive on the external trigger input, or as a remote software trigger or a manual key press.





Captured measurement sweeps can be selected for display which, by default, shows one to four selected S-parameters across a maximum of 64 individually coloured traces, all plotted over the band of operation. The plotted sweeps can be any subset of all the captured sweeps and data can be normalized to one of the captured sweeps, which is useful for examining changes from sweep to sweep.

The plots to the right show S_{21} (magnitude and normalized magnitude in dB) for 16 states of a programmable step attenuator. The plot beneath and right plots S_{21} and S_{11} at a user-selected frequency of 986 MHz. Here the horizontal axis plots measurement sweep number, each in this case representing a unique state of the attenuator. All four S-parameters can be displayed simultaneously in this way on the graphs. Using a hardware external trigger and maximum resolution bandwidth, all the data for these plots was captured within 1 second!

The captured sweep data can be saved to disk in a number of formats, including Touchstone®, for use with third-party applications. Data can be saved grouped by S-parameter, for example. The file list on the right shows the files created for the stepping attenuator. You simply enter the name *Step_Attn* when saving the data, and the family of files shown is automatically created. In each of these files each column contains the S-parameter data for a given sweep. The first column after the frequency column contains data from the first sweep, the second has data from the second sweep and so on.

The data can also be saved for any single frequency within the sweep range used to capture the data. There is also an option to save the entire dataset for later use.

Name

-  Step_Attn_S11.dat
-  Step_Attn_S12.dat
-  Step_Attn_S21.dat
-  Step_Attn_S22.dat

Data can be saved to disk ordered by S-parameter

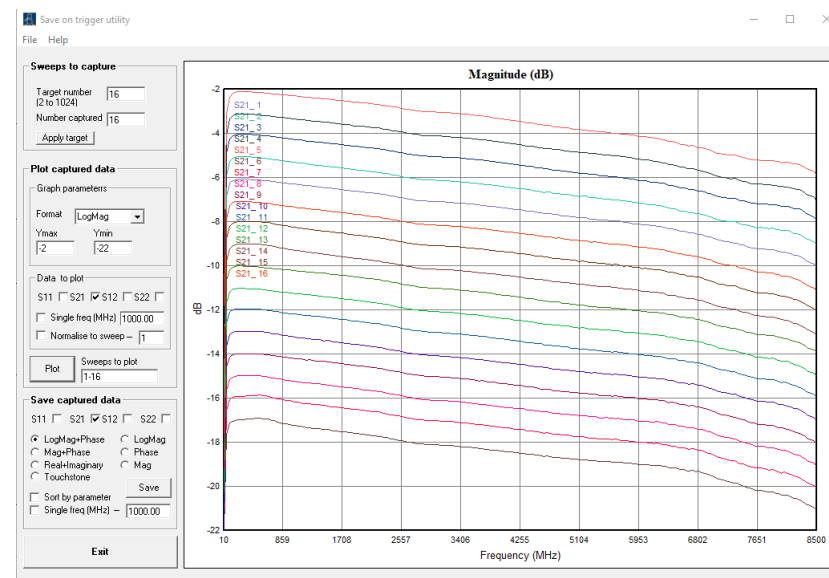

Capture and inspect multiple traces of one or multiple S-parameters. These are S_{21} plots for sixteen 1 dB increments of a step attenuator.

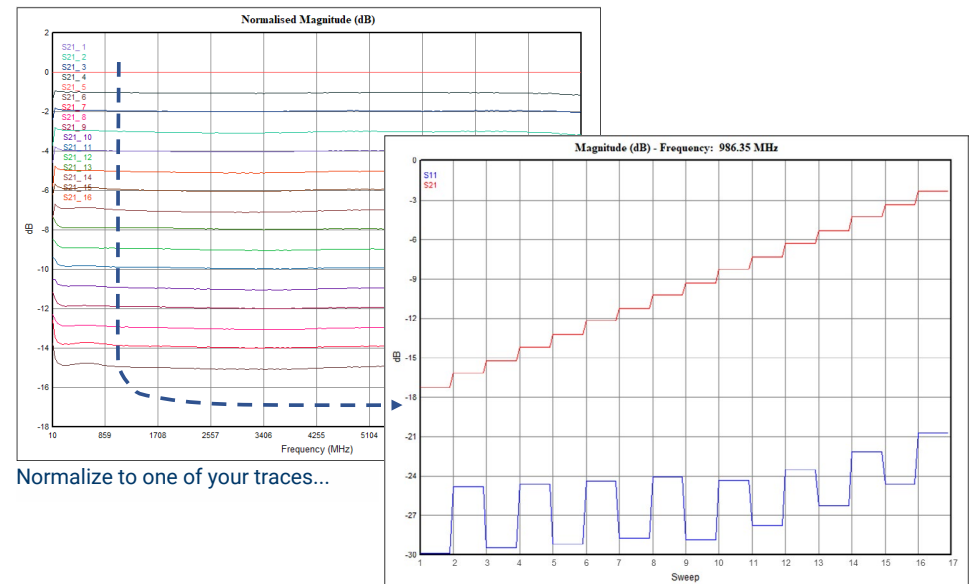

Normalize to one of your traces...

... or plot a slice through your data at a single frequency. These are S_{21} and S_{11} at 986.35 MHz.

Mixer measurements utility (PicoVNA 108 only)

External local oscillator and external power sensor support

A wide range of mixer performance and port isolation measurements can be carried out, including swept RF or IF with a choice of low or high side LO. A PicoSource AS108 or a third-party signal source is used as the external LO source, and this operates under the control of the PicoVNA 3 PC application. The software also supports a third-party USB power sensor in the characterization of port power.

Supported USB-controlled signal sources	Supported USB-controlled power sensors
PicoSource® AS108	Agilent / Keysight U8480, U2000
MiniCircuits SSG-15G, SSG-6000, SSG-6001	Rohde & Schwarz NRP8S, NRP8SN, NRP18S
TTi TGR 6000	
Contact Pico if you'd like us to consider support for your choice of external USB signal generator or power sensor.	

VSWR correction

Mixers can be difficult to measure accurately particularly when mixer port match is relatively poor. The PicoVNA 108 mixer measurement calibration includes the option of VSWR error correction. This reduces the conversion loss measurement uncertainty as typically shown in the diagram.

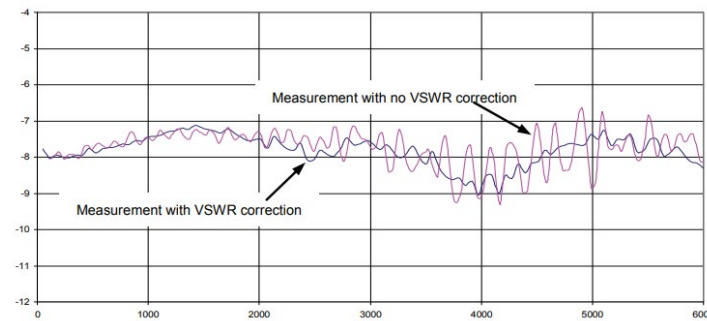

Mixer compression

Conversion loss change as a function of the input RF level is easily determined. This can be referenced either to the port power uncertainty of the PicoVNA, or you can use a third-party power sensor (above) to pre-characterize the PicoVNA 108 port power for enhanced accuracy. The 0.1 and 1 dB compression points are displayed on completion.

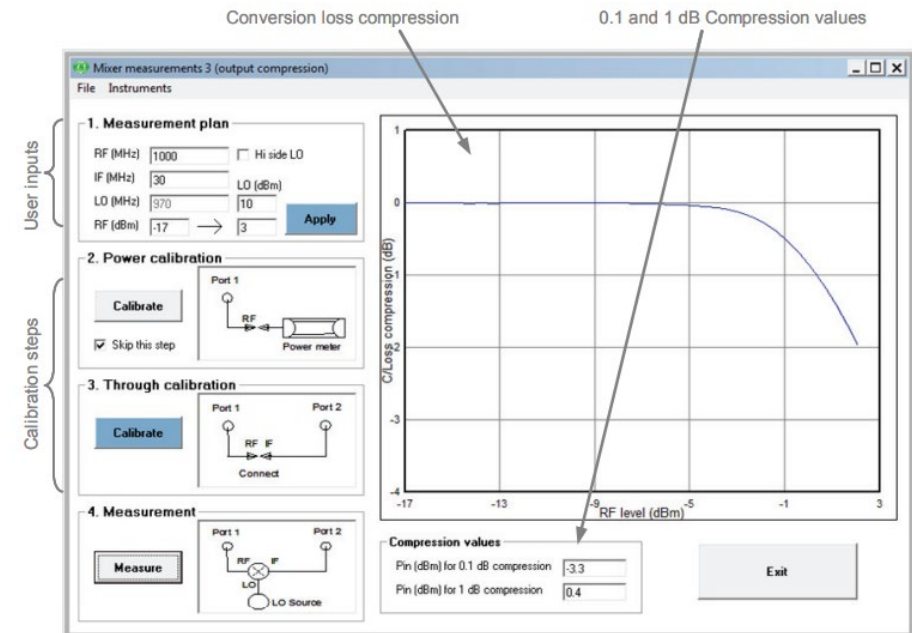
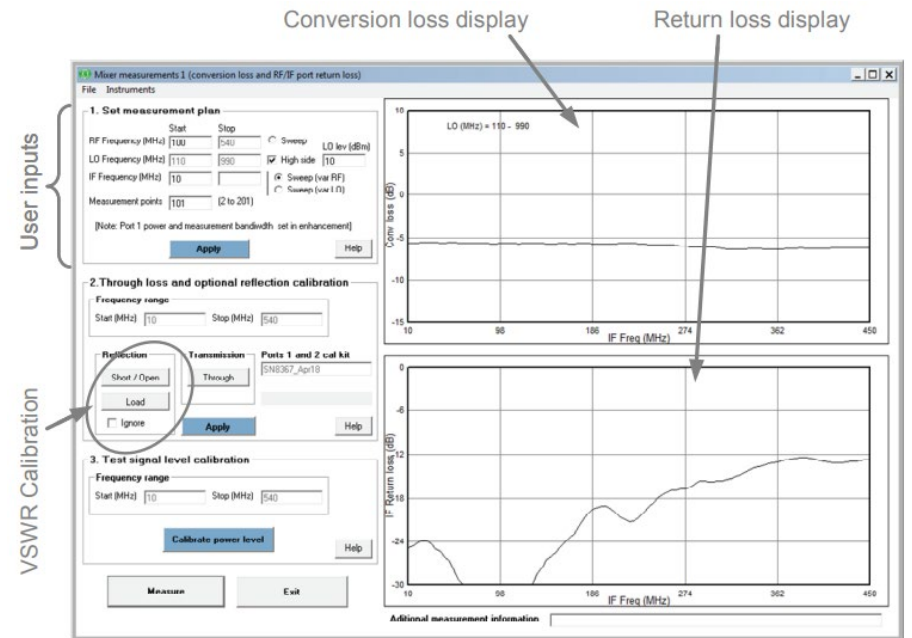

Check standard comparison utility

The supplied Touchstone measurement data for a serial-numbered check standard is loaded into the PicoVNA memory trace as a 'Reference' measurement.

With a valid, full S-parameter, full-span calibration established and the check standard connected between the test ports, the comparison utility performs a measurement. It then compares and tabulates, on each frequency point basis, the measurement with the stored 'Reference' data. Magnitude and phase difference are tabulated.

The utility combines uncertainties for the instrument and test leads (respective specifications) with measurement uncertainty and stability of the check standard (also supplied). The difference between reference and measurement is then compared with total uncertainty, giving a result of 'pass' (within uncertainty) or 'fail' (outside uncertainty).

You can save the comparison dataset for archive or analysis.

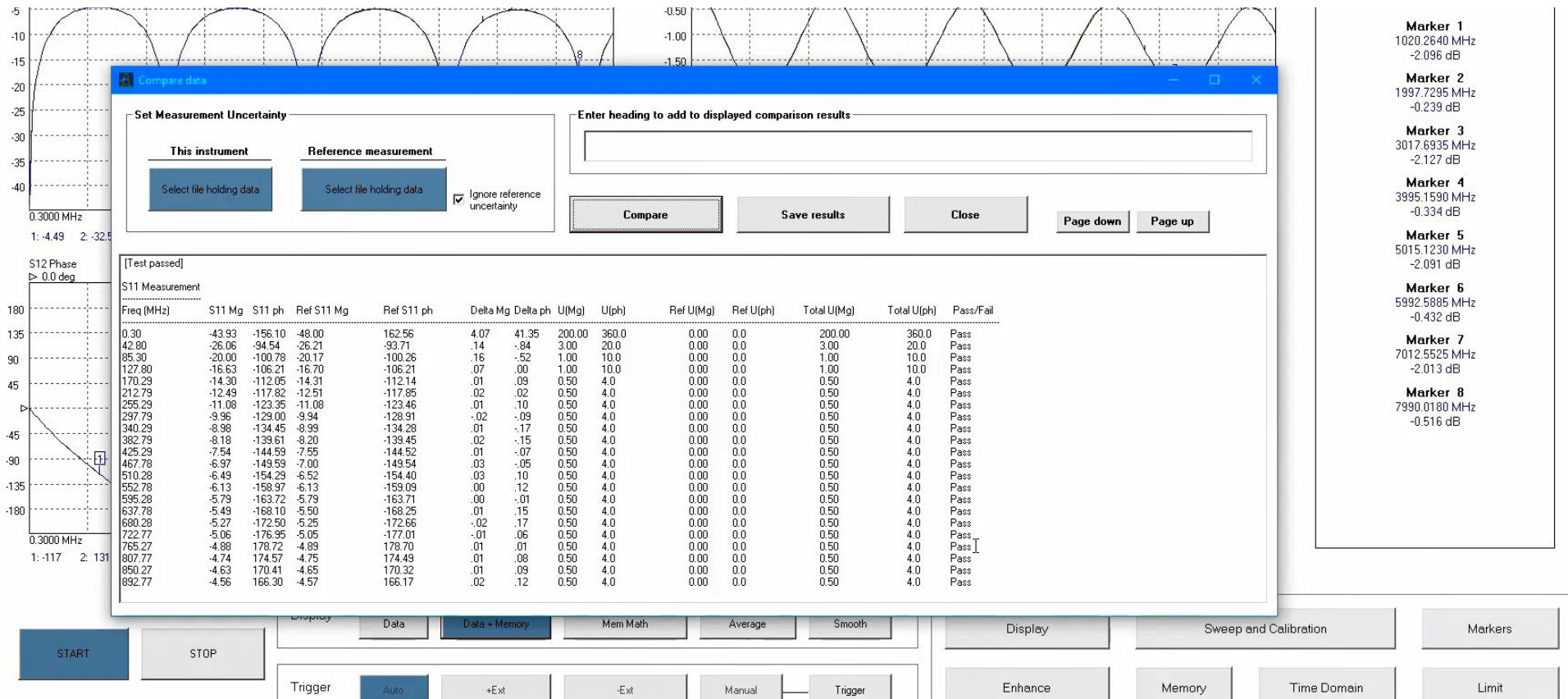

This is a very demanding evaluation of an instrument, test leads and the calibration performed, very nearly, to the full specification of the instrument and leads. The test is designed to identify a weak process, or worn, contaminated or damaged system components that might lead to a compromised measurement. To gain a pass, correct calibration procedure must be followed including the use of torque wrenches to make the connections at calibration and comparison measurements. The uncertainty data provided attempts to take into account the expected variability of your measurement setups when mating the check standard with Pico-supplied PC3.5 or SMA port connectors. There is a wide variation in the quality of commercially available test cables and SMA connectors, and contamination, damage or wear can easily occur. We guarantee that the uncertainty data provided will cover your test setups only when you use Pico-supplied calibration standards, port adaptors and test leads in new condition.

Specifications

Standard conditions: 10 Hz resolution bandwidth, at 13 dBm (PicoVNA 106) or 0 dBm (PicoVNA 108) test power, at an ambient temperature of between 20 °C and 30 °C but within 1°C of the calibration temperature and 60 minutes after power-up.

Receiver characteristics							
Parameter	Value					Conditions	
Measurement bandwidth	140 kHz, 70 kHz, 35 kHz, 15 kHz, 10 kHz, 5 kHz, 1 kHz, 500 Hz, 100 Hz, 50 Hz, 10 Hz						
Average displayed noise floor	PicoVNA 106			PicoVNA 108			Relative to the test signal level set to maximum power after an S_{21} calibration. Ports terminated as during the isolation calibration step.
	Band (MHz)	Typical (dB)	Max. (dB)	Band (MHz)	Typical (dB)	Max. (dB)	
	0.3 to 10	-110	-100	0.3 to 1	-100	-90	
	10 to 4000	-118	-108	1 to 6000	-124	-110	
	> 4000	-110	-100	> 6000	-120	-100	
Dynamic range	See graphs (typical, excludes crosstalk)					10 Hz bandwidth Maximum test power +6 dBm (6 GHz), 0 dBm (8.5 GHz). No averaging	

Dynamic range 0.3 MHz to 10 MHz (PicoVNA 106)

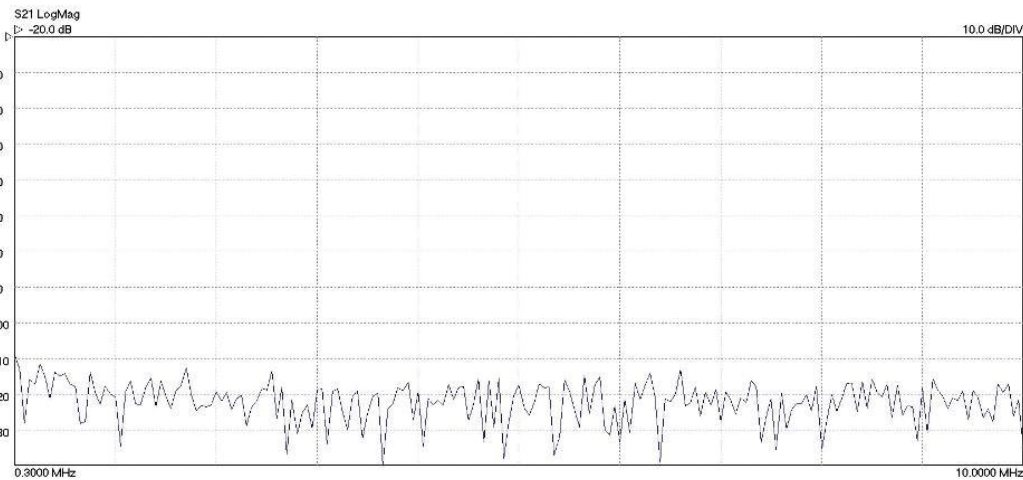

Dynamic range 10 MHz to 6 GHz (PicoVNA 106)

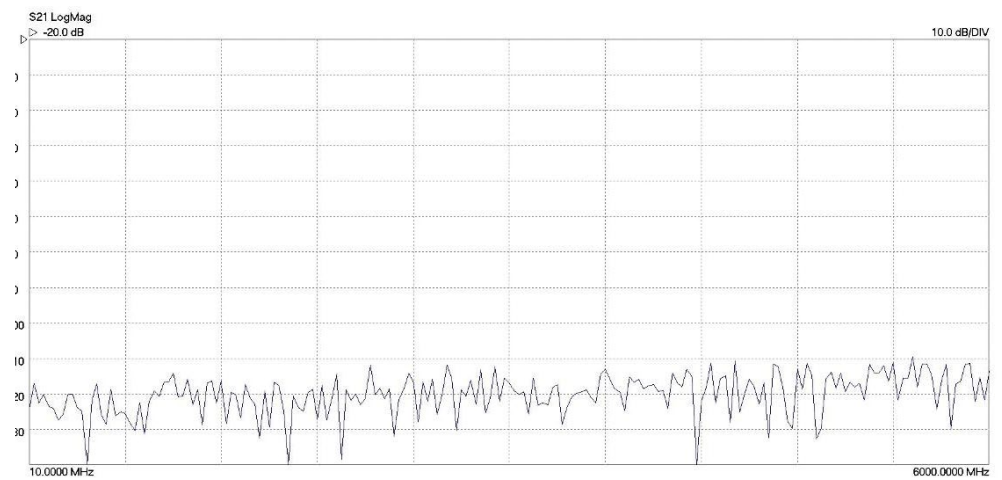

Dynamic range 0.3 MHz to 10 MHz (PicoVNA 108)

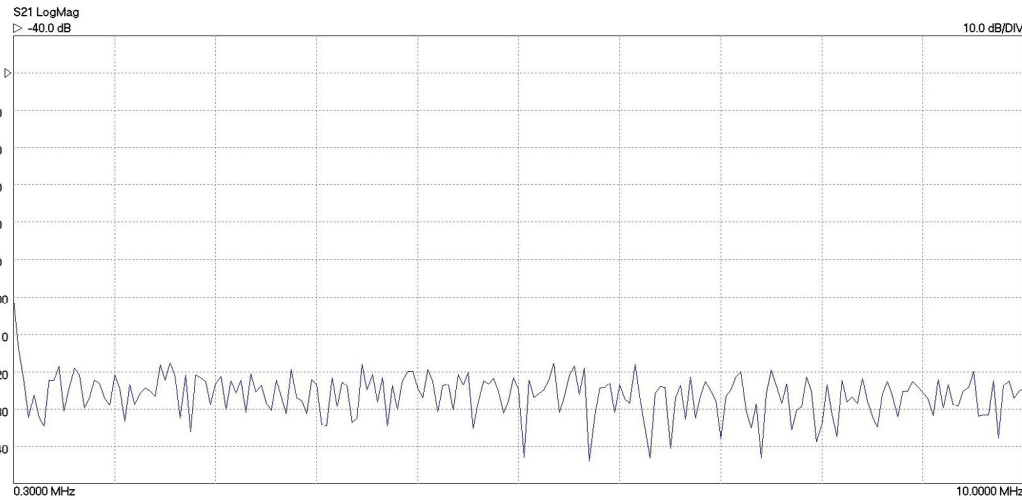

Dynamic range 10 MHz to 8.5 GHz (PicoVNA 108)

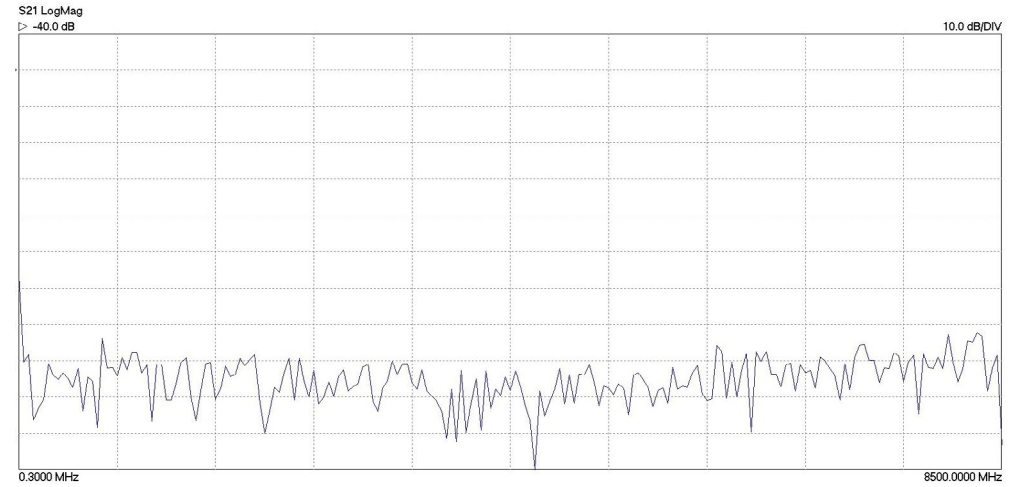

Temperature stability, typical	0.02 dB/°C for F < 4 GHz 0.04 dB/°C for F ≥ 4 GHz		Measured after an S ₂₁ calibration		
Trace noise (RMS)	Bandwidth (kHz)	Typical (dB)	Max. (dB)		
	10	0.0008	0.002		
	70	0.003	0.005		
	140	0.005 (6 GHz) / 0.006 (8.5 GHz)	0.01		
Measurement uncertainty PC3.5 test port interfaces	Reflection		Transmission		
	Freq. range	Level range	Mag. / phase	Level range	Mag. / phase
	< 2 MHz	-15 dBm to 0 dBm	0.7 dB / 8°	0 dBm to +6 dBm ^[6]	0.4 dB / 6°
	> 2 MHz		0.5 dB / 4°	+10 dBm ^[8]	0.2 dB / 2°
	< 2 MHz	-25 dBm to -15 dBm	0.8 dB / 6°	-40 dBm to 0 dBm	0.2 dB / 2°
	> 2 MHz		1.0 dB / 10°	0 dBm	0.1 dB / 1°
	< 2 MHz	-30 dBm to -25 dBm	3.0 dB / 20°	-60 dBm to -40 dBm	0.5 dB / 8°
	> 2 MHz		2.5 dB / 15° ^[6]		0.3 dB / 4° ^[6]
			3.0 dB / 20° ^[8]		0.2 dB / 4° ^[8]
	< 2 MHz			-80 dBm to -60 dBm	2.0 dB / 15°
> 2 MHz			-60 dBm	1.5 dB / 12°	
[6] PicoVNA 106, [8] PicoVNA 108					
<p>Test level of -3 dBm. No averaging. Bandwidth 10 Hz. Ambient temperature equal to the calibration temperature.</p> <p>A 12 error term calibration is assumed carried out with a good quality 3.5 mm calibration kit capable of achieving the performance specified.</p> <p>These values are supplied with our Check Standard on USB memory stick as uncertainty data file:</p> <p>"Instrument Uncertainty with Premium PC3.5 leads 106.dat" or: "Instrument Uncertainty with Premium PC3.5 leads 108.dat"</p> <p>PicoVNA 3: Uncertainty files are installed with the software.</p>					

Measurement uncertainty SMA test port interfaces			Reflection		Transmission		<p>Test level of -3 dBm. No averaging. Bandwidth 10 Hz. Ambient temperature equal to the calibration temperature.</p> <p>A 12 error term calibration is assumed carried out with a good-quality SMA or PC3.5 calibration kit capable of achieving the performance specified.</p> <p>These values are supplied with our Check Standard on USB memory stick as uncertainty data file:</p> <p>"Instrument Uncertainty with Pico Standard SMA Leads 106.dat" or: "Instrument Uncertainty with Pico Standard SMA Leads 108.dat"</p> <p>Uncertainty files are installed with the software. The main spurious response occurs close to (2 x RF + 1.3) MHz or (3 x RF + 2.6), where RF is the test frequency in MHz. For example, when testing a bandpass filter with a centre frequency of 1900 MHz, an unwanted response will occur around 632.47 MHz or 949.35 MHz. In all known cases the levels will be as stated.</p>
	Freq. range	Level range	Mag. / phase	Level range	Mag. / phase		
	< 2 MHz	-15 dBm to 0 dBm	0.99 dB / 11.3°	0 dB to	0.57 dB / 8.5°		
	> 2 MHz		0.71 dB / 5.7°	+6 dBm ^[6] +10 dBm ^[8]	0.28 dB / 2.8°		
	< 2 MHz	-25 dBm to -15 dBm	1.13 dB / 8.5°	-40 dBm to	0.42 dB / 2.8°		
	> 2 MHz		1.41 dB / 14.1°	0 dBm	0.14 dB / 1.4°		
	< 2 MHz	-30 dBm to -25 dBm	4.24 dB / 28.3°	-60 dBm to	0.71 dB / 11.3°		
	> 2 MHz		3.54 dB / 21.2°	-40 dBm	0.42 dB / 5.7°		
< 2 MHz			-80 dBm to	2.83 dB / 21.2°			
> 2 MHz			-60 dBm	2.12 dB / 17.0°			
[6] PicoVNA 106 [8] PicoVNA 108							
Spurious responses	-76 dBc typical, -70 dBc max.						
Test port characteristics							
Load match	Corrected: 40 dB min. corrected, 46 dB, typ.						
	Uncorrected: 16 dB (PicoVNA 106) or 15 dB (PicoVNA 108), typ.						
Source match	Corrected: 40 dB min. corrected, 46 dB, typ.						
	Uncorrected: 16 dB (PicoVNA 106) or 15 dB (PicoVNA 108), typ.						
Directivity	40 dB min. corrected, 47 dB, typ. corrected						
Crosstalk	PicoVNA 106			PicoVNA 108			
	Band (MHz)	Typ. (dB)	Max. (dB)	Band (MHz)	Typ. (dB)	Max. (dB)	
	< 2	-100	-90	< 1	-100	-90	
	2 to 4000	-110	-90	2 to 6000	-110	-90	
4000 to 6000	-100	-90	6000 to 8500	-100	-90		
Maximum input level	+10 dBm, typ.						
Maximum input level	+20 dBm			+23 dBm			
Impedance	50 Ω						
Connectors	Type N, female						
Bias-T input characteristics							
Maximum current and DC voltage	250 mA, ±15 V						
Current protection	Built-in resettable fuse						
DC port connectors	SMB(m)						

Sweep I/O characteristics		
Sweep trigger output voltage	Low: 0 V to 0.8 V. High: 2.2 V to 3.6 V.	
Sweep trigger input voltage	Low: -0.1 V to 1 V. High: 2.0 V to 4 V.	
Sweep trigger input voltage	±6 V	No damage
Sweep trigger in/out connectors	BNC female on back panel	
Measuring functions		
Measuring parameters	S_{11} , S_{21} , S_{22} , S_{12} P1dB (1 dB gain compression) AM to PM conversion factor (PM due to AM) Mixer conversion loss, return loss, isolation and compression (PicoVNA 108 only)	
Error correction	12 error term full S-parameter correction (insertable DUT) 12 error term full S-parameter correction (noninsertable DUT) 8 error term full S-parameter unknown through correction (noninsertable DUT) S_{11} (1-port correction) De-embed (2 embedding networks may be specified) Impedance conversion S_{21} (normalize, normalize + isolation) S_{21} (source match correction + normalize + isolation) Averaging, smoothing Hanning and Kaiser–Bessel filtering on time-domain measurements Electrical length compensation (manual or auto) Effective dielectric constant correction	
Display channels	4 channels	
Traces	Up to 4 live traces, two plot parameters and/or plot axis scalings per display channel	
Display formats	Amplitude (logarithmic and linear), phase, group delay, VSWR, real, imaginary, Smith chart, polar, time domain	
Memory trace	Up to 4 memory traces per display channel	
Limit lines	6 segments on one trace, per channel (overlap allowed)	
Markers	8 markers	
Marker functions	Normal, Δ marker, fixed marker, peak/min. hold, 3 dB and 6 dB bandwidth	

Sweep functions			
Sweep type	Linear frequency sweep, CW time-based sweep, and power sweep (P1dB utility)		
Sweep times	Bandwidth	S₁₁, S₂₁, S₁₁+S₂₁ calibration	Full 12 or 8 term calibration
	140 kHz	19 ms ^[1]	37 ms ^[1]
	10 kHz	37 ms	72 ms
	1 kHz	0.21 s	0.42 s
	100 Hz	1.94 s	3.87 s
	10 Hz	19.2 s	38.4 s
	LF Adder (for each low frequency point < 2.5 MHz)	1.25 ms/pt	2.5 ms/pt
	[1] 20 ms and 38 ms for PicoVNA 108		
Number of sweep points, VNA mode	51, 101, 201, 401, 801, 1001, 2001, 4001, 5001, 6001, 7001, 8001, 9001, 10 001		
Number of sweep points, TD mode	512, 1024, 2048, 4096		
$T_{SWP}(s) = N \times (T_{MIN} + F_{BW} / R_{BW})$ where: N = number of frequency points $T_{MIN}(s)$ = minimum time / point (s2p: 167 μs; s1p: 85 μs) F_{BW} = bandwidth settle factor (s2p: 1.91; s1p: 0.956) R_{BW} = resolution bandwidth (Hz) For sweep repetition period, add software rearm time: T_{ARM} = average 6.5 ms or worst case 50 ms For markers on, increase T_{ARM} by 39 ms			
Signal source characteristics			
Frequency range	PicoVNA 106		PicoVNA 108
	300 kHz to 6.0 GHz		300 kHz to 8.5 GHz
Frequency setting resolution	10 Hz		
Frequency accuracy	10 ppm max		
Frequency temperature stability	±0.5 ppm/°C max		
Harmonics	-20 dBc max		
Non-harmonic spurious	-40 dBc typical		
Phase noise (10 kHz offset)	0.3 MHz to 1 GHz: -90 dBc/Hz		
	1 GHz to 4 GHz: -80 dBc/Hz		
	> 4 GHz: -76 dBc/Hz		
Test signal power	< 10 MHz: -3 to -20 dBm		≤ 6 GHz: +10 dBm to -20 dBm
	10 MHz to 4 GHz: +6 to -20 dBm		> 6 GHz: +6 dBm to -20 dBm
	> 4 GHz: +3 to -20 dBm		
Power setting resolution	0.1 dB		
Power setting accuracy	±1.5 dB		
Reference input frequency	10 MHz ±6 ppm		
Reference input level	0 ±3 dBm		
Reference output level	0 ±3 dBm		

Manual calibration kits						
	Frequency	PC3.5(f)	PC3.5(m)	SMA(f)*	SMA(m)*	
Load uncorrected return loss	≤ 3 GHz > 3 GHz	≥ 30 dB ≥ 27 dB	≥ 30 dB ≥ 26 dB	≥ 30 dB ≥ 26 dB	≥ 28 dB ≥ 26 dB	* SMA kits are calibrated in a PC3.5 reference system.
Load corrected return loss	≤ 3 GHz > 3 GHz	≥ 46 dB ≥ 43 dB	≥ 46 dB ≥ 43 dB	≥ 40 dB ≥ 37 dB	≥ 40 dB ≥ 37 dB	Inferred from directivity after applying correction using measured data provided with the kit
Open circuit return loss	≤ 3 GHz > 3 GHz			≤ 0.15 dB ≤ 0.2 dB		
Short circuit return loss	≤ 3 GHz > 3 GHz			≤ 0.2 dB ≤ 0.25 dB		
Through adaptor insertion loss	≤ 6 GHz	≤ 0.15 dB	≤ 0.15 dB	≤ 0.15 dB	≤ 0.2 dB	
Transfer calibration method	300 kHz to 1.5 GHz 1.5 GHz to 6 GHz	SOLT comparison TRL comparison		SOLT comparison		SOLT = short, open, load, through TRL = through, reflect, line
Automated E-Cal kits						
Port interface and impedance	2x 50 Ω SMA(f) ports					
Port input limits	+10 dBm operating, +20 dBm/1 V pk protection					
Bandwidth	300 kHz to 8.5 GHz					
Directivity	40 dB					
Source match	40 dB					
Load match	36 dB					
Reflection tracking	0.05 dB					
Transmission tracking	0.04 dB					
Transfer calibration method	SOLT comparison					Characterization data records to internal memory
Control and power	USB 2.0 (micro)					
Dimensions	65 mm L x 43 mm W x 15 mm H					Including connectors and feet
Weight	60 g					
Temperature (operating)	5 °C to 40 °C					
Temperature (oven control range)	+18 °C to 28 °C					To meet quoted accuracy
Oven warming time	45 s typical at 23 °C					
Humidity (operating)	5% to 80% RH non-condensing					
Temperature (storage)	-20 °C to 50 °C					
Humidity (storage)	5% to 80% RH non-condensing					

Check standards

Devices	Bandwidth	Return loss		Insertion loss		
TA430 CHK-INS-MF insertable TA431 CHK-NON-F noninsertable	0.3 to 8500 MHz	< -30 dB to > -6 dB		> -0.2 dB to < -1.9 dB		Formed by 75 mm of 25 Ω mismatched line
Reference uncertainty	Reflection		Transmission			Ambient temperature 20 °C to 26 °C These values are supplied with our Check Standard on USB memory stick as uncertainty data file: "Check Standard Reference Measurement Uncertainty.dat". The software installs the two uncertainty files.
	Freq. range	Level range	Mag. / phase	Level range	Mag. / phase	
	< 2 MHz	-15 dB to	0.99 dB / 11.3°	0 dB to	0.57 dB / 8.5°	
	> 2 MHz	0 dB	0.71 dB / 5.7°	+6 dB	0.28 dB / 2.8°	
	< 2 MHz	-25 dB to	1.13 dB / 14.1°	-40 dB to	0.42 dB / 2.8°	
	> 2 MHz	-15 dB	1.41 dB / 8.5°	0 dB	0.14 dB / 1.4°	
	< 2 MHz	-30 dB to	4.24 dB / 28.3°	-60 dB to	0.71 dB / 11.3°	
	> 2 MHz	-25 dB	3.54 dB / 21.2°	-40 dB	0.42 dB / 5.7°	
	< 2 MHz			-80 dB to	2.83 dB / 21.2°	
> 2 MHz			-60 dB	2.12 dB / 17.0°		

Note: The Pico TA430 and TA431 check standards can be used in the performance verification of the PicoVNA but they have too much uncertainty to make a confident verification to the full performance specification of the instrument. Nonetheless, the uncertainty of the verification, given in the result from the compare utility, may be low enough for the application. If sufficient, the use of either TA430 or TA431, of course, significantly reduces ownership costs and increases the regularity with which a verification can be made.

Miscellaneous

	PicoVNA 106	PicoVNA 108	
Controlling PC data interface	USB 2.0		
Support for third party test software	Dynamic Link Library (DLL) as part of user interface software		
External dimensions	286 mm L x 174 mm W x 61 mm H		Including connectors and feet
Weight	1.85 kg	1.9 kg	
Temperature range (operating)	5 °C to 40 °C		
Temperature range (storage)	-20 °C to +50 °C		
Humidity	80% max, non-condensing		
Vibration (storage)	0.5 g, 5 Hz to 300 Hz		
Power supply voltage	+12 to +15 V DC		
Power consumption	22 W	25 W	
Power source connector	5.5 mm diameter hole, 2.1 mm diameter centre contact pin. Centre pin is positive.		
Host PC requirements	Microsoft Windows 7, 8 or 10 2 GB RAM or more		
Safety	Conforms to EN 61010-1:2019 and EN 61010-2-030:2010		
Warranty	3 years		

PicoVNA 106 (PQ111) and PicoVNA 108 (PQ112) kit contents

<p>PicoVNA vector network analyzer Calibrated. Certificate with data available separately.</p>		<p>TA336 Standard test lead with SMA(m) port TA337 Standard test lead with SMA(f) port TA338 Premium test lead with PC3.5(m) port TA339 Premium test lead with PC3.5(f) port</p>	
<p>PS010 Universal input 12 V 4.5 A output power supply</p>		<p>TA340 Standard PC3.5 port adaptor (m-m) TA341 Standard PC3.5 port adaptor (f-f) TA354 Standard PC3.5 port saver (m-f) TA342 Premium SMA port adaptor (m-m) TA343 Premium SMA port adaptor (f-f) TA357 Premium SMA port saver (m-f)</p>	
<p>PA153 PicoVNA carry case</p>		<p>TA344 Standard SOLT calibration kit SMA(m) with data TA345 Standard SOLT calibration kit SMA(f) with data TA346 Premium SOLT calibration kit PC3.5(m) with data TA347 Premium SOLT calibration kit PC3.5(f) with data</p>	
<p>DI111 PicoVNA software and documents on USB flash drive</p>		<p>TA518 SOLT-AUTO-M 8.5 GHz E-Cal calibration kit SMA(m) TA519 SOLT-AUTO-F 8.5 GHz E-Cal calibration kit SMA(f) TA520 Dual gender 8.5 GHz E-Cal calibration kit SMA(m, f)</p>	
<p>TA486 PicoWrench RF combination wrench For N, SMA, PC3.5 and K-type connectors. Quantity: 2.</p>		<p>TA430 Insertable check standard SMA(m-f) with data TA431 Noninsertable check standard SMA(f-f) with data</p>	
<p>MI106 Pico blue USB 2.0 cable 1.8 m</p>		<p>CC046 PicoVNA calibration and certificate with data CC047 Recalibration of standard calibration kit CC048 Recalibration of premium calibration kit CC050 Remeasurement of check standard CC057 Recalibration of E-Cal automated calibration kit</p>	
<p>Accessories available separately</p>		<p>PQ186 Network Metrology Training Kit PQ189 Network Metrology Training PCA (only)</p>	
<p>TA356 Dual-break torque wrench SMA / PC3.5 / K-type TA358 Dual-break torque wrench N-type Both types: 1 N·m / 8.85 in·lb</p>		<p>PQ187 Network Metrology Leader Standard Kit PQ188 Network Metrology Leader Premium Kit</p>	